

GHOST

GHOST

Diffusore

in vetro di sicurezza monostrato, serigrafato per versione con led strip e trasparente per versione con led di potenza.

- *diffuser: Serigraph Security glass for StripLed version and transparente version for power Led.*
- *Abdeckung: Aus Einscheiben-Sicherheitsglas im Siebdruckverfahren hergestellt für die Version mit LED-Stripe und transparent für die Version mit Hochleistungs-LED.*
- *diffuseur: En verre de sécurité sérigraphié pour version stripLed et transparent pour version avec led de puissance.*
- *Difusor: en vidrio de seguridad mono-estrato, serigrafado para versión con LED strip y transparente para versión con LED de potencia.*

Corpo

in acciaio INOX.

- *Frame: stainless steel.*
- *Gehäuse: Aus Edelstahl.*
- *Corps: en acier inoxydable.*
- *Cuerpo: en acero inoxidable.*

Controcassa

allestimento in acciaio disponibile di due altezze diverse: la versione da 120 mm è carrabile, quella da 90 mm è calpestabile o a carrabilità limitata.

Fornita con profilo necessario per installazione.

- *Outer-casing: Equipment in steel available in two different height: One version of 120mm that is drive-over, the 90mm is a walk-over or limited driver-over. Provided with necessary profile for the final installation.*
- *Einbaugehäuse: Gehäuse aus Stahl, lieferbar mit zwei verschiedenen Höhen, und zwar in der befahrbaren Version mit 120 mm und in der begehbaren oder eingeschränkt befahrbaren Version mit 90 mm.*
- *Das zur Installation erforderliche Profil wird mitgeliefert.*
- *Boîtier d'encastrement: Equipement en acier disponible en différente mesures résistant au passage de voiture et de personne. Fournis avec profile nécessaire pour l'installation.*
- *Contracaja: preparación en acero disponible con dos alturas diferentes: la versión de 120 mm transitable, la de 90 mm se puede pisar o transitar de forma limitada. Suministrada con perfil necesario para instalar.*

Connettore

rapido in metallo nichelato IP68 con giunzione a ghiera precablato in PUR. Accessorio incluso.

- *Connectors: Fast metal nikelated ip68 with junction cabled in PUR. Accessory included.*
- *Stecker: Schnellstecksystem aus vernickeltem Metall IP68 mit Ringschraubendichtung, vorverkabelt aus PUR. Zubehör mitgeliefert.*
- *Schnellstecker aus vernickeltem Metall IP 68.*
- *Connecteurs: rapide en métal nickelé IP68 avec jonction pré-cablé en PUR. Accessoire inclus.*
- *Conector: rápido en metal níquelado IP68 con unión de anillo pre-cableado en PUR. Accesorio incluido.*

LINEE LUMINOSE
LIGHT LINES

GHOST LIGHT LINES



FIXING

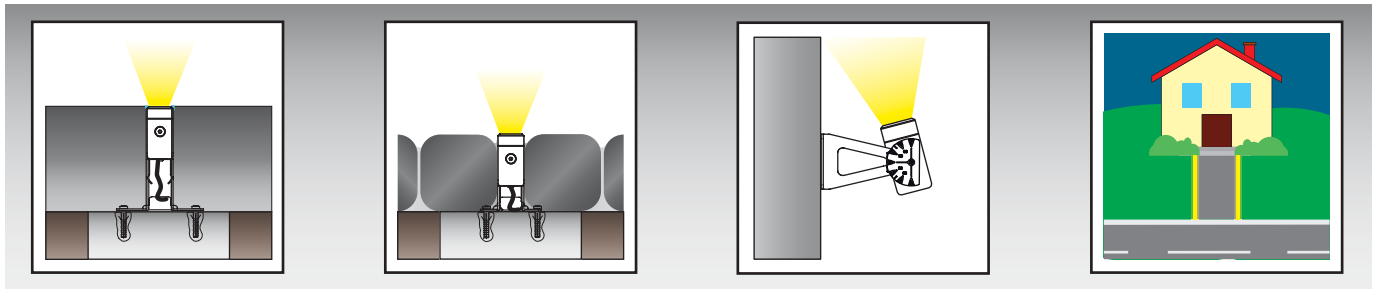

PHOTOMETRICAL CURVES

20°

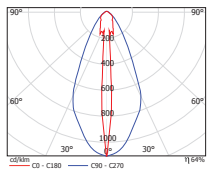
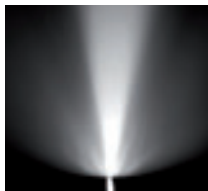

50°

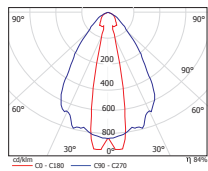
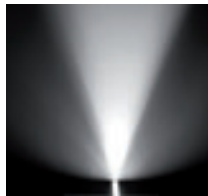

ASYMMETRICAL

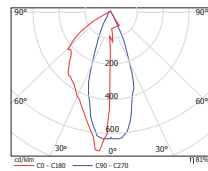
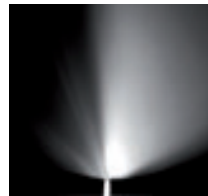

WALLWASHER

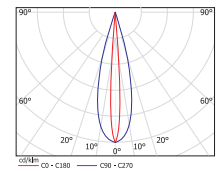
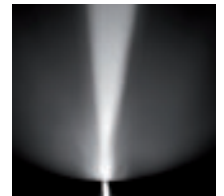

Le curve fotometriche si riferiscono a Ghost Mono da 486 mm con colore Cold White e sono indicative

Photometric curves refer to the Starline Mono 320mm with Natural White color and are indicative

GHOST POWER

C.V.	MONO	106
C.V.	RGB	107

LED: POWER
EMISSION: ASYMMETRIC - 20° - 50°
COLOUR: MONO, RGB
CABLE: 2x 0,25 m CABLE 0.5 mm²
DRIVER: INCLUDED
POWER: 2W LED
PROTECTION: HIGH (IP67)

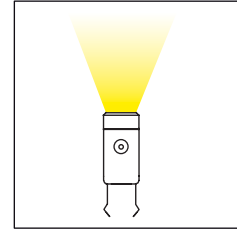

LENGHT
 486 mm
 736 mm

GHOST STRIP LINE

C.V.	MONO	108
C.V.	RGB	109

LED: STRIP
EMISSION: DIFFUSED
COLOUR: MONO, RGB
CABLE: 2x 0,25 m CABLE 0.5 mm²
DRIVER: INCLUDED
POWER: STRIP POWERED
PROTECTION: HIGH (IP67)

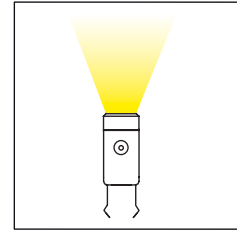

LENGHT
 486 mm
 736 mm

GHOST ARCHITECTURAL

C.V.	MONO	112
C.V.	RGB	113

LED: POWER
EMISSION: ASYMMETRIC - 20° - 50°
COLOUR: MONO, RGB
CABLE: 1 m NEOPRENE CABLE + PG9 CABLE GLAND
DRIVER: INCLUDED
PROTECTION: HIGH (IP67)

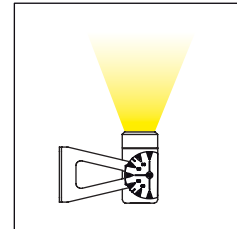

LENGHT
 486 mm
 736 mm

ACCESSORIES

OUTER-CASINGS



110

CONNECTORS



111

SUITABLE ELECTRONICS

C.V.

LED CONTROLGEARS



226

DRIVER STRIP



233

DRIVERS



231

INTERFACES



242

GHOST MONO

POWER



Corpo in acciaio inox 316. Diffusore in vetro temprato.
La barra va installata solo ed esclusivamente con controcassa da specificare in fase d'ordine.
Connettore e convertitore incluso.

*Stainless steel 316 frame. Tempered glass diffuser.
The item has to be installed only and exclusively with a outer-casing that has to be specified on the order.
Connector and convertitor included.*

Gehäuse aus Edelstahl V4a(316). Abdeckung aus Sicherheitsglas im unteren Bereich. Installation der Leiste ausschließlich mit Einbaugehäuse möglich, das bei der Bestellung angegeben werden muss. Schnellstecksystem inbegriffen.

*Corps en acier inox 316. Diffuseur en verre trempé. La barre doit être installée seulement et exclusivement avec un boîtier double à spécifier au moment de la commande.
Connecteur inclu.*

*Cuerpo en acero inox 316. Difusor en vidrio templado. La barra se instalará sólo y exclusivamente con contracaja, se especificará en el pedido.
Conector incluido.*



2x 0,25 m cable
4 x 0,5 mm²

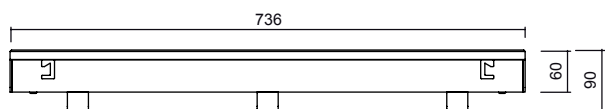
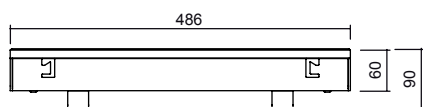

	n° led 2W	Code	Outer-casing
I	4	88870	89282 89284
I	6	88871	89283 89285



Colours	Optical	Code	Accessories
C	20°	20	<div style="border: 1px solid black; padding: 5px;"> <p>CONTROCASSE OUTER-CASINGS</p>  <p style="text-align: right;">110</p> </div>
W	50°	50	
N	Asimm	07	
B			
Y			
R			
G			



GHOST RGB POWER



Corpo in acciaio inox 316. Diffusore in vetro temprato.
La barra va installata solo ed esclusivamente con controscassa da specificare in fase d'ordine.
Connettore e convertitore incluso.

*Stainless steel (316) frame. Tempered glass diffuser.
The item has to be installed only and exclusively with a outer-casing that has to be specified on the order.
Connector and convertitor included.*

Gehäuse aus Edelstahl 316. Abdeckung aus Sicherheitsglas im unteren Bereich. Installation der Leiste ausschließlich mit Einbaugehäuse möglich, das bei der Bestellung angegeben werden muss. Schnellstecksystem inbegriffen.

*Corps en acier inox 316. Diffuseur en verre trempé. La barre doit être installée seulement et exclusivement avec un boîtier double à spécifier au moment de la commande.
Connecteur inclu.*

*Cuerpo en acero inox 316. Difusor en vidrio templado. La barra se instalará sólo y exclusivamente con contracaja, se especificará en el pedido.
Conector incluido.*

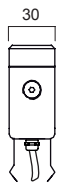

2x 0,25 m cable
5 x 0.5 mm²

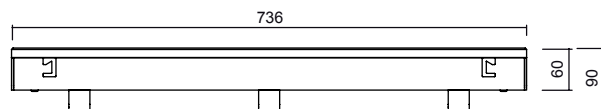
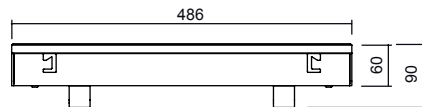

	n° led 2W	Code	Outer-casing	
I	12	88872	89282	
			89284	
I	18	88873	89283	
			89285	



Colours	Optical	Code	Accessories
---------	---------	------	-------------

Z	20°	20	<div data-bbox="640 1893 913 2199" data-label="Complex-Block"> <p>CONTROCASSE OUTER-CASINGS</p> <p> 110</p> </div>
	50°	50	
	Asimm	07	

STRIP INFO 137

GHOST MONO STRIP LINE

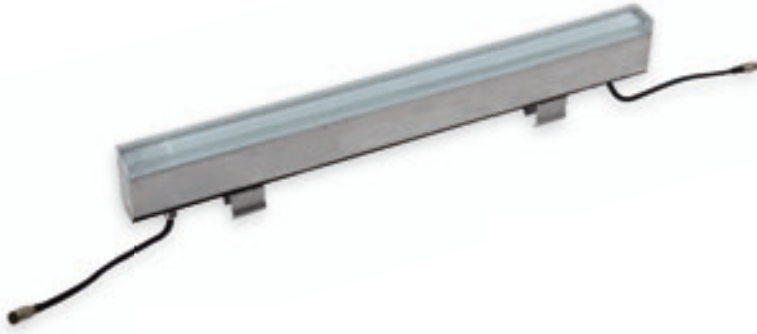

Corpo in acciaio inox 316. Diffusore in vetro temprato, parte inferiore serigrafata. La barra va installata solo ed esclusivamente con controcassa da specificare in fase d'ordine.
Connettore e convertitore incluso.

Stainless steel 316 frame. Tempered glass diffuser, bottom part serigraphy.

The item has to be installed only and exclusively with a outer-casing that has to be specified on the order.

Connector and convertitor included.

Gehäuse aus Edelstahl V4a(316). Abdeckung aus Sicherheitsglas im unteren Bereich. Installation der Leiste ausschließlich mit Einbaugehäuse möglich, das bei der Bestellung angegeben werden muss. Schnellstecksystem inbegriffen.



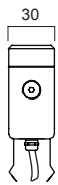

Corps en acier inox 316. Diffuseur en verre trempé, partie inférieure sérigraphiée. La barre doit être installée seulement et exclusivement avec un boîtier double à spécifier au moment de la commande. Connecteur inclu.

Cuerpo en acero inox 316. Difusor en vidrio templado, parte inferior serigrafiada. La barra se instalará sólo y exclusivamente con contracaja, se especificará en el pedido. Conector incluido.

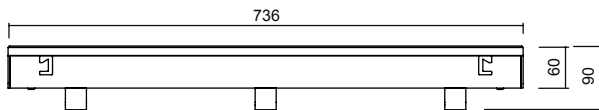
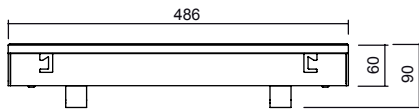

2x 0,25 m cable
4 x 0,5 mm²



	Power (W)	Code	Outer-casing
I	12 W	88874	89282 
			89284 
I	18 W	88875	89283 
			89285 



Colours	Optical	Code	Accessories
<ul style="list-style-type: none"> ● C ● W ● B ● Y ● R ● G 	Diffused	00	<div style="border: 1px solid black; padding: 5px;"> <p>CONTROCASSE OUTER-CASINGS</p>  <p style="text-align: right;"> 110</p> </div> <div style="text-align: right; margin-top: 10px;">  STRIP INFO  137 </div>

GHOST RGB STRIP LINE



Corpo in acciaio inox 316. Diffusore in vetro temprato, parte inferiore serigrafata. La barra va installata solo ed esclusivamente con controcassa da specificare in fase d'ordine.
Connettore e convertitore incluso.

*Stainless steel 316 frame. Tempered glass diffuser, bottom part serigraphy.
The item has to be installed only and exclusively with a outer-casing that has to be specified on the order.
Connector and convertitor included.*

Gehäuse aus Edelstahl V4a(316). Abdeckung aus Sicherheitsglas im unteren Bereich. Installation der Leiste ausschließlich mit Einbaugeschäule möglich, das bei der Bestellung angegeben werden muss. Schnellstecksystem inbegriffen.

*Corps en acier inox 316. Diffuseur en verre trempé, partie inférieure sérigraphiée. La barre doit être installée seulement et exclusivement avec un boîtier double à spécifier au moment de la commande.
Connecteur inclu.*

*Cuerpo en acero inox 316. Difusor en vidrio templado, parte inferior serigrafiada. La barra se instalará sólo y exclusivamente con contracaja, se especificará en el pedido.
Conector incluido.*

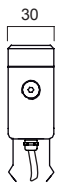

2x 0,25 m cable
5 x 0.5 mm²

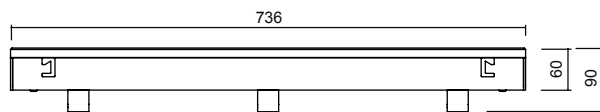
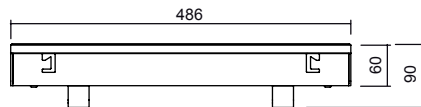

	Power (W)	Code	Outer-casing
I	5 W	88876	89282
			89284
I	7 W	88877	89283
			89285



Colours	Optical	Code	Accessories
Z	Diffused	00	<div style="border: 1px solid black; padding: 5px;"> <p>CONTROCASSE OUTER-CASINGS</p>  <p style="text-align: right;"> 110</p> </div> <div style="text-align: right; margin-top: 10px;"> STRIP INFO 137 </div>

ACCESSORIES



CONTROCASSE / OUTER-CASING

GHOST

Controcasse in acciaio AISI 304 con falso profilo in ferro da rimuovere nel corso dell'installazione. Disponibili in versione carrabile (89282 e 89283) e calpestabile (89284 e 89285).

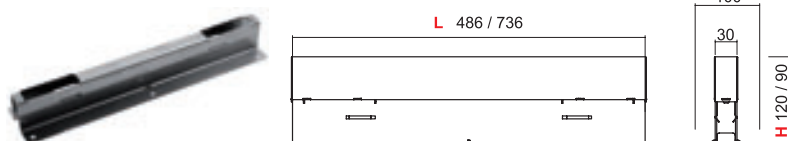
Stainless steel AISI 304 outer-casing with iron false-profile to be removed during the installation. Available in drive-over version (89282 and 89283) and walk-over version (89284 and 89285)



	Code	L	H
	I 89282	486 mm	120 mm
	I 89283	736 mm	120 mm
	I 89284	486 mm	90 mm
	I 89285	736 mm	90 mm

INSTALLATION

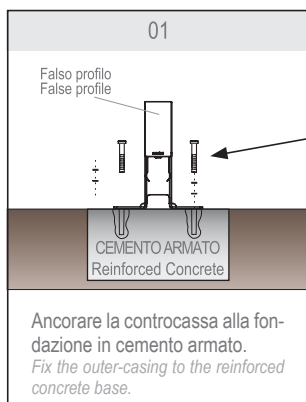

Utilizzare tasselli appositamente dimensionati M6 non inclusi
Use sized rawplugs M6 not included

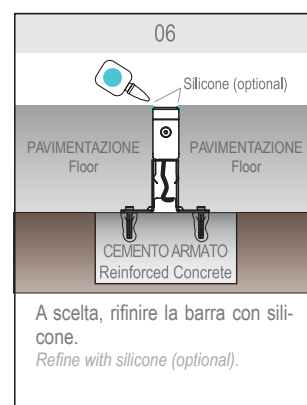
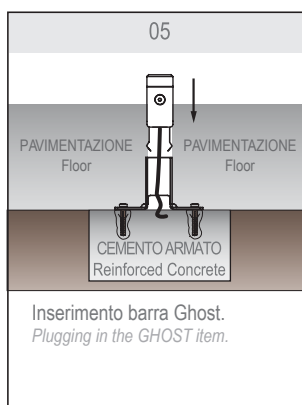
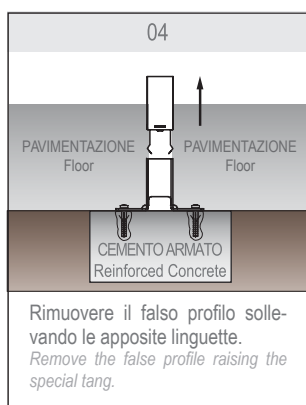
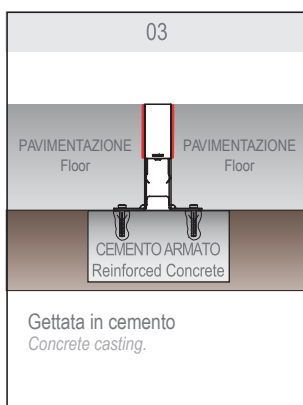
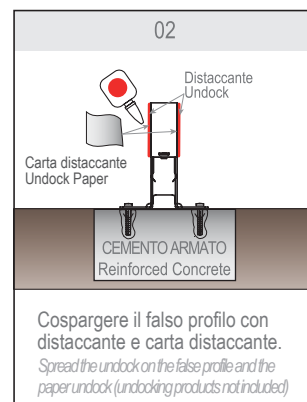

UNINSTALL

Per rimuovere la ghost una volta installata vi è un'apposita chiave che è inclusa col prodotto.

To remove the ghost once installed there is a special key that is included with the product.

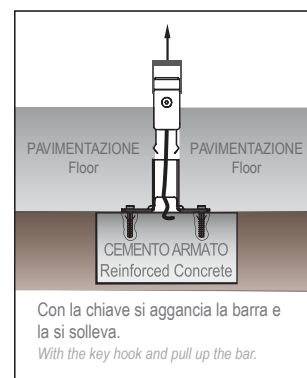
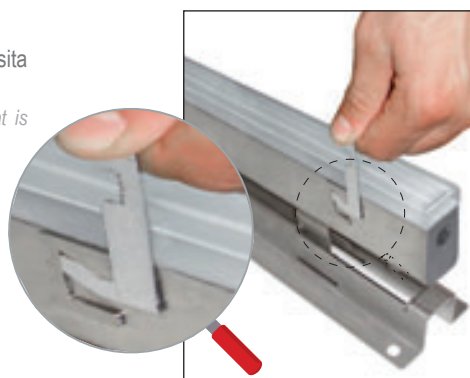

WIRING

CONNETTORI E PROLUNGHE / CONNECTORS AND EXTENSIONS

Cavo in PUR con connettore M12 volante femmina.
PUR cable with a movable female M12 connector.

TECHNICAL DATA

Code	L	Section	F
89190	5 m	4x0,5 mm ²	4 poli 24V AC MONO
89362	5 m	5x0,5 mm ²	5 poli RGB

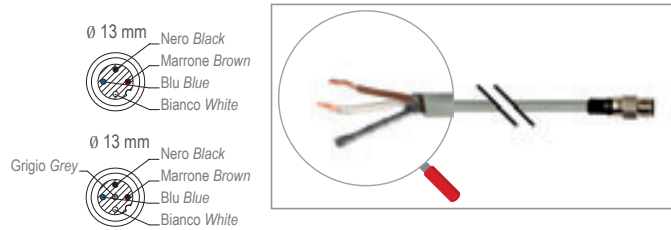

Prolunga in PUR con connettori M12 volanti maschio e femmina
PUR extension with movable male and female M12 connectors.

TECHNICAL DATA

Code	L	Section	M-F
89188	10 m	4x0,5 mm ²	4 poli 24V AC MONO
89361	10 m	5x0,5 mm ²	5 poli RGB



WIRING

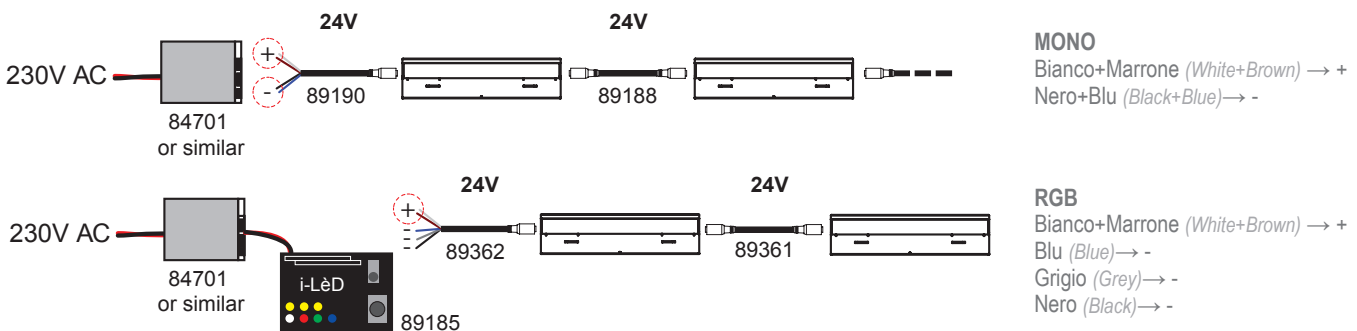

Nel caso in cui le controcasse non vengano installate in modo consecutivo, predisporre tra una controcassa e l'altra un tubo corrugato di minimo Ø 20 mm.

If the recessing housings are not installed consecutively, it is necessary to include, between them, a corrugated pipe at least 20 mm in diameter.

n° barre collegabili in linea continua sullo stesso switching (mono) o centralina (RGB).

È possibile collegare più barre in parallelo sullo stesso driver utilizzando un alimentatore Power Switching con potenza adeguata. Il connettore dell'ultima barra rimane chiuso per mezzo del tappino (in dotazione).

No. of bars which can be connected in a linear series to the same switching power supply unit (mono) or to the same controller (RGB).

Several bars can be connected in parallel to the same driver by means of a switching power supply unit with a suitable power. The connector of the last bar must be closed with the end cap supplied.

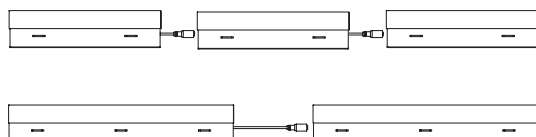

GHOST	POWER		STRIP	
	MONO	RGB	MONO	RGB
486 mm	10	4	8	16
736 mm	6	3	5	10

GHOST MONO

POWER ARCHITECTURAL

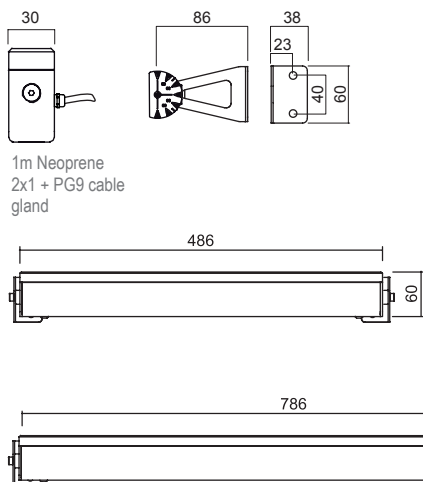

Corpo in acciaio inox 316. Diffusore in vetro temprato. Installazione con staffe incluse. Convertitore incluso. Ideale per luoghi acidi e marini

Body in 316 stainless steel. Diffuser in toughened glass, printed bottom. The installation does not require a recessed housing; application with brackets. Connector included. Ideal for acids and marine sites.

Gehäuse aus Edelstahl V4a(316). Abdeckung aus Sicherheitsglas im unteren Bereich. Profil aus eloxiertem Aluminiumpressteil 6060 mit Power Led.

Die Installation erfordert kein Einbaugeschloß; die montage ist mit Steigbügel. Lineare Optik aus Polycarbonat. Stecker inbegriffen. Ideal für Säuren und marinen Standorte.

Corps en acier inox 316. Diffuseur en verre trempé, partie inférieure sérigraphiée. Le boîtier double n'est pas nécessaire pour l'installation; application avec étriers. Connecteur inclus. Idéal pour les sites marins et acides.

Cuerpo en acero inox 316. Difusor en vidrio templado, parte inferior serigrafiada. Ideal para espacios marinos y ácidos.

No se necesita la contracaja para instalarla; aplicar con abrazaderas. Conector incluido.

	n° led 2W	Code
	4	89335
	6	89336



Colours	Optical	Code	Staffe - Brackets
C	20°	20	<p>STAFFE BRACKETS</p> <p>INCLUDED</p>
W	50°	50	
N	Asimm	07	
B			
Y			
R			
G			

GHOST RGB POWER ARCHITECTURAL

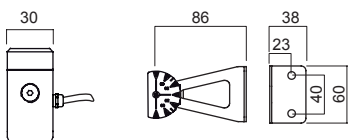

1m Neoprene
6x1 + PG9 cable
gland

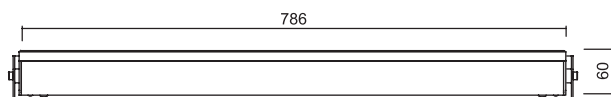
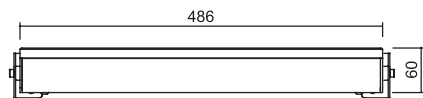

Corpo in acciaio inox 316. Diffusore in vetro temprato.
Installazione con staffe incluse.
Convertitore incluso.
Ideale per luoghi acidi e marini

Body in 316 stainless steel. Diffuser in toughened glass, printed bottom. The installation does not require a recessed housing; application with brackets. Connector included.
Ideal for acids and marine sites.

Gehäuse aus Edelstahl V4a(316). Abdeckung aus Sicherheitsglas im unteren Bereich. Profil aus eloxiertem Aluminiumpressteil 6060 mit Power Led.

Die Installation erfordert kein Einbaugeschloß; die montage ist mit Steigbügel. Lineare Optik aus Polycarbonat. Stecker inbegriffen.
Ideal für Säuren und marinen Standorte.

Corps en acier inox 316. Diffuseur en verre trempé, partie inférieure sérigraphiée. Le boîtier double n'est pas nécessaire pour l'installation; application avec étriers. Connecteur inclus.
Idéal pour les sites marins et acides.

Cuerpo en acero inox 316. Difusor en vidrio templado, parte inferior serigrafiada. Ideal para espacios marinos y ácidos.
No se necesita la contracaja para instalarla; aplicar con abrazaderas. Conector incluido.

	n° led 2W	Code
	12	89337
	18	89338



Colours	Optical	Code	Staffe - Brackets
Z	20°	20	<div style="text-align: center;"> <p>STAFFE BRACKETS</p> <p>INCLUDED</p> </div>
	50°	50	
	Asimm	07	