

CAP18 è - living outside

Illuminare gli spazi esterni regala nuove prospettive di luce per rivestire facciate di abitazioni e palazzi, per colorare in modo inaspettato alberi e siepi, per rendere più visibili angoli in ombra. I faretti da giardino installati in particolare a bordo viale permettono di creare diversi disegni di luce e di funzionare da comodi segnapassi.

The illumination of outdoor spaces gives new light perspectives to beautify the front of homes and buildings, to colour trees and shrubs in an unexpected way and to make dark corners more visible. The garden spotlights, that are in particular installed along the perimeter of the path, create various light effects and become handy path markers.

Illuminer les espaces extérieurs c'est découvrir de nouvelles perspectives de lumière pour revêtir les façades des habitations et des édifices, pour colorer de façon originale les arbres et les haies, pour rendre plus visibles les coins d'ombre. Les spots du jardin installés le long de l'allée permettent de créer des dessins lumineux et font également office de repères de passage.

Iluminar los espacios exteriores ofrece nuevas perspectivas de luz para fachadas de viviendas y palacios, a fin de colorear de manera inesperada árboles y setos, para hacer más visibles los rincones oscuros. Los focos de jardín instalados en especial al borde del camino permiten crear distintos dibujos de luz y sirven para la señalización de paseos.

Die Beleuchtung der Außenbereiche schenkt neue Lichtperspektiven für Haus- und Gebäudefassaden, taucht Bäume und Hecken in unerwartete Farbe und macht dunkle Ecken sichtbar. Die vor allem am Wegrand installierten Gartenstrahler schaffen unterschiedliche Lichteffekte und dienen gleichzeitig als bequeme Schrittlichter.



Zone esterne di frequente utilizzo come scale o viali di passaggio sono pienamente illuminati. Inoltre grazie alle ottiche orientabili si crea un effetto anti abbagliante. Cyga 3led 2watt / Frequently-used outdoor areas such as stairs or walkways are fully-lit. Furthermore, thanks to the directional optical lenses, the effect is non-glare. Cyga 3 leds 2 watt / Les zones extérieures fréquemment utilisées comme les escaliers ou les allées de passage sont totalement illuminées. De plus, grâce aux lentilles optiques orientables, on crée un effet anti-éblouissant. Cyga 3 leds 2 watts / Las zonas exteriores de uso frecuente como las escaleras o los caminos de acceso están alumbradas perfectamente. Además, gracias a las ópticas orientables, se crea un efecto antideslumbrante. Cyga 3 leds 2 watt / Oft benutzte Außenbereiche wie Treppen und Fußwege werden so voll ausgeleuchtet. Dank der verstellbaren Optiken wird außerdem Blendfreiheit garantiert. Cyga 3 LED 2 Watt.

524 | CAP 18

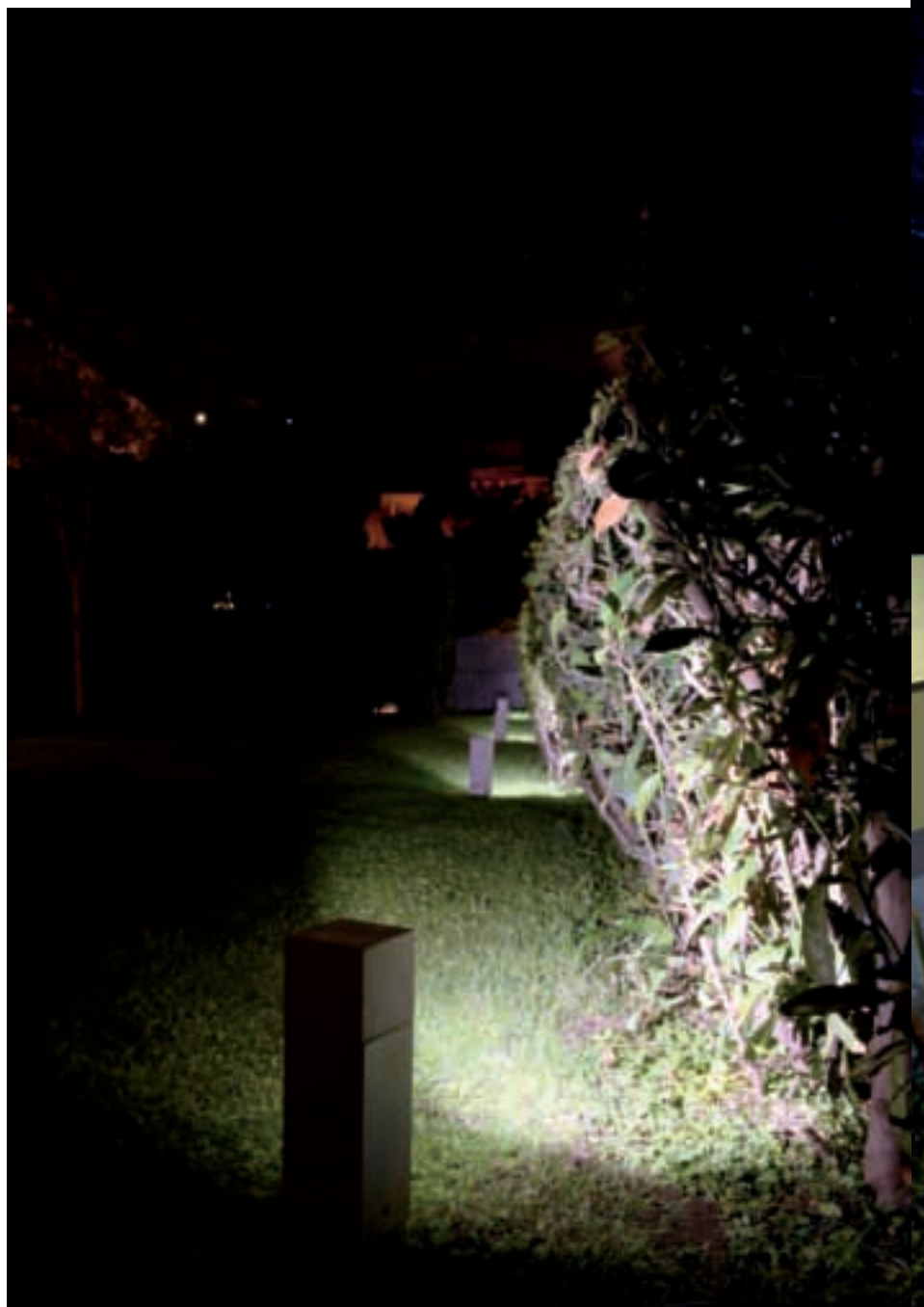

Come delineare il giardino e relativa siepe con il prodotto Elop 2 led 2 watt / How to illuminate the garden and a shrub using the Elop 2 leds 2 watt light / Comment marquer le contour du jardin et de la haie grâce au produit Elop 2 leds 2 watts / Cómo perfilar el jardín y el seto con el producto Elop 2 leds 2 watt / Gelungene Markierung des Gartens und der Hecke mit dem Produkt Elop 2 led 2 Watt.

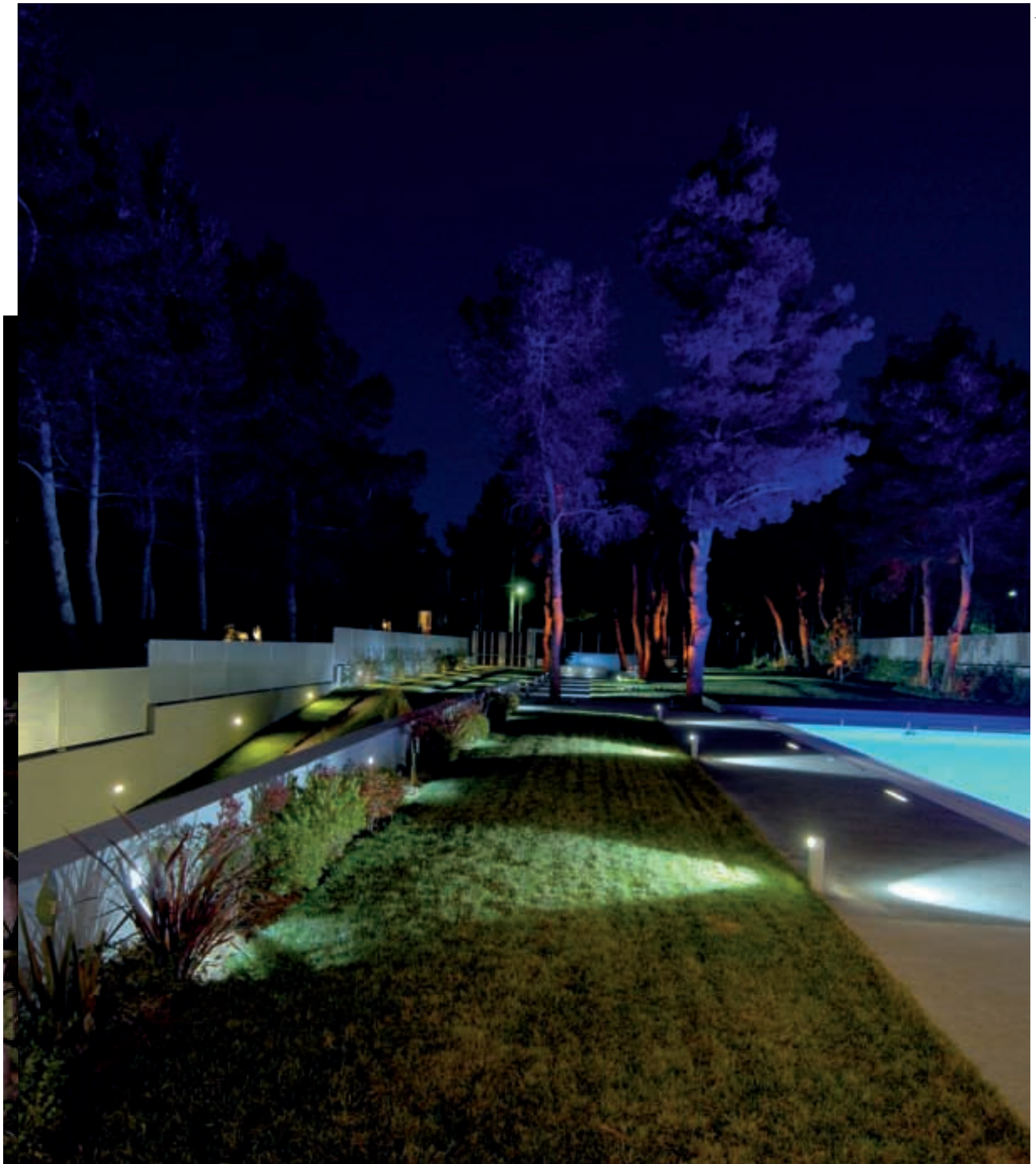

L'aspetto decorativo si coniuga in modo ottimale con l'aspetto funzionale: il giardino viene appropriatamente illuminato negli spazi di passaggio e il contesto viene indirettamente arricchito dalla simmetria dei faretto.

Decorative aspects combine perfectly with functional ones: the garden pathways are well- and the context is indirectly beautified by the symmetry of the lights.

L'aspect décoratif se conjugue parfaitement avec l'aspect fonctionnel: le jardin est illuminé de façon appropriée dans les zones de passage et son contexte est indirectement enrichi par la symétrie des spots.

La estética se conjuga perfectamente con el aspecto funcional: el jardín está oportunamente iluminado en los espacios de paso y el contexto se enriquece indirectamente por la simetría de los focos.

Das dekorative Aussehen verbindet sich auf optimale Weise mit dem funktionellen Aspekt: Der Garten wird in den begehbaren Zonen ausreichend beleuchtet und der Gesamteindruck indirekt durch die Symmetrie der Strahler verschönt.

Progetto: Abitazione privata - Grecia
Lighting Design: IFI Group

*Project: Private home - Greece
Lighting Design: IFI Group*

*Projet: Habitation privée - Grèce
Design éclairage: IFI Group*

*Proyecto: Vivienda particular - Grecia
Lighting Design: IFI Group*

*Projekt: Privates Wohngebäude - Griechenland
Lighting Design: IFI Group*

Prodotti: Amdam 2+2 led 2 watt

Products used: Amdam 2+2 leds 2 watt

Produits: Amdam 2+2 leds 2 watts

Productos: Amdam 2+2 leds 2 watt

Produkte: Amdam Flex 2+2 led 2 Watt

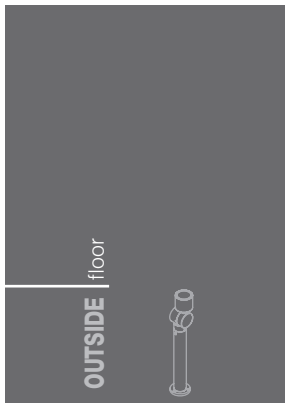

OUTSIDE floor

Cyga



Cyga

Corpo illuminante per esterni con faretto regolabile. Struttura interamente in alluminio.

Outdoor pillar with adjustable spotlight. Full aluminium structure.

Petit poteau avec réglable pour extérieur. Structure entièrement en Aluminium.

Aparato para exterior con foco regulable y estructura enteramente en aluminio.

Leuchte für Außenräume mit einstellbarer Leuchte. Struktur ganz aus Aluminium.

	2 Watt	1 Watt
	3 LED	3 LED
G	85459	85458

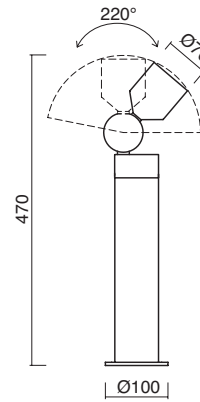

Driver NON compreso

Driver not included
Driver non compris
Driver no incluido
exklusive Driver

vedi cap. Driver
See Driver section
Voir chapitre Drivers
Ver capitulo Driver
siehe Kap. "Driver"

600 mA 350mA 1,000 1,260

Opticals	code	Colours
10°	10	● C
30°	30	● W
50°	50	○ N
70°	70	● B
120°	12	● Y
		● R
		● G

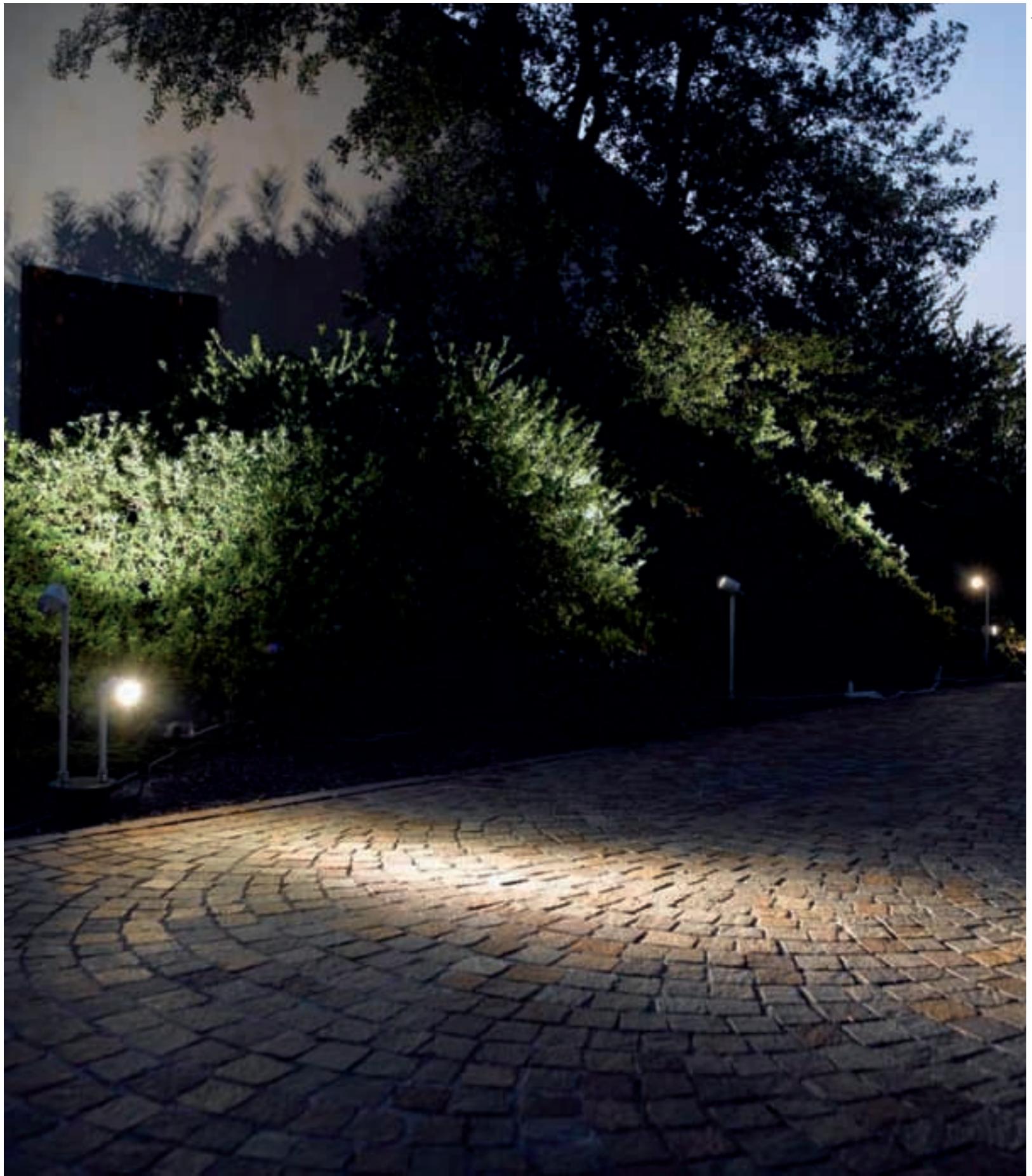

L'illuminazione da giardino può rispondere a diverse esigenze estetiche e funzionali. In particolare prodotti innovativi come i paletti Dan si distinguono per la facilità d'installazione e l'incasso a terra grazie alla presenza di controcassa.

Garden lighting can meet various aesthetic and practical requirements. In particular, innovative products such as the Dan lampposts stand out for their installation ease and because they can be sunk into the ground thanks to the counter-housing.

L'éclairage des jardins est en mesure de répondre à toute exigence esthétique et fonctionnelle. Notamment, certains produits innovateurs comme l'éclairage sur pied Dan se caractérisent par leur facilité d'installation et leur pose au sol par emboîtement grâce à la présence d'un logement.

La iluminación del jardín puede satisfacer distintas exigencias estéticas y funcionales. En especial algunos productos novedosos como las balizas Dan se caracterizan por su fácil instalación y encastrado en el suelo gracias a la caja de conexión rápida.

Die Beleuchtung des Gartens kann unterschiedliche ästhetische und funktionelle Ansprüche erfüllen. Innovative Produkte wie die Pfahlampen Dan zeichnen sich besonders durch einfache Installation und eine im Lieferumfang enthaltene Bodeneinbaudose aus.

Progetto: abitazione privata - Treviso - Italy
Lighting Design: LineaLight Group

Project: private home - Treviso - Italy
Lighting Design: LineaLight Group

Projet: maison privée - Trévise - Italie
Design éclairage: LineaLight Group

Proyecto: Vivienda particular - Treviso - Italia
Lighting Design: LineaLight Group

Projekt: Privates Wohngebäude - Treviso - Italien
Lighting Design: LineaLight Group

Prodotti: Dan 3+3led 2 watt

Products used: Dan 3+3 leds 2 watt

Produits: Dan 3+3 leds 2 watts

Productos: Dan 3+3 leds 2 watt

Produkte: Dan 3+3 LED 2 Watt

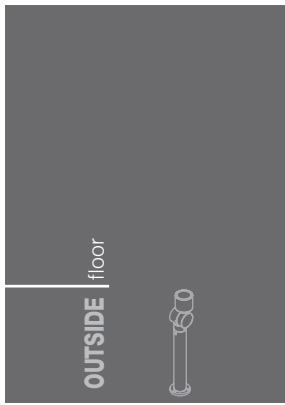

OUTSIDE floor

Cyga



Cyga

Corpo illuminante per esterni con faretto regolabile. Struttura interamente in alluminio.

Outdoor pillar with adjustable spotlight. Full aluminium structure.

Petit poteau avec spot réglable pour extérieur. Structure entièrement en Aluminium.

Aparato para exterior con foco regulable y estructura enteramente en aluminio.

Leuchte für Außenräume mit einstellbarer Leuchte. Struktur ganz aus Aluminium.

	2 Watt	1 Watt
	3 LED	3 LED
G	85461	85460

Driver compreso

Driver included
Driver compris
Driver incluido
inklusive Driver

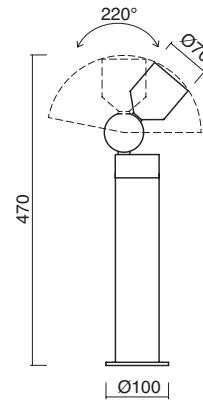

600mA 350mA 1,000 1,260

Opticals	code	Colours
10°	10	C
30°	30	W
50°	50	N
70°	70	B
120°	12	Y R G

OUTSIDE floor



Dan



Dan

Aparato para exterior con dos focos regulables en aluminio con base apta para enterrar y para una instalación sencilla y veloz. No necesita operaciones especiales para la instalación.

Leuchte für Außenräume mit einstellbarer Doppelleuchte aus Aluminium mit einer Basis, die versenkt werden kann, für eine einfache und schnelle Installation. Es sind keine besonderen Installationsarbeiten notwendig.

Corpo illuminante per esterni con doppio faretto regolabile in alluminio con base atta ad essere interrata per una semplice e veloce installazione. Non necessita di particolari opere per l'installazione.

Outdoor adjustable double spotlight, full aluminium, with a special base for the ground suitable for a simple and rapid installation.

Phare pour extérieure avec double spots réglables en Aluminium

2 Watt 1 Watt
3 + 3 LED 3 + 3 LED

G 87684 87681

G 87685 87682

G 87686 87683

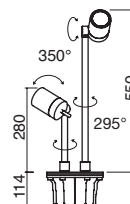
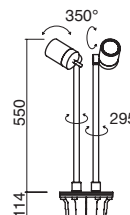
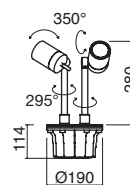

Driver compreso

Driver included
Driver compris
Driver incluido
inklusive Driver



Opticals	code	Colours
10°	10	● C
30°	30	● W
50°	50	○ N
70°	70	● B
120°	12	● Y
		● R
		● G

Controcassa inclusa nell'articolo
Outercasing included in the item
Boîtier fourni avec l'article
Contracaja incluida en el artículo
Das Montagegehäuse ist im Artikel eingeschlossen

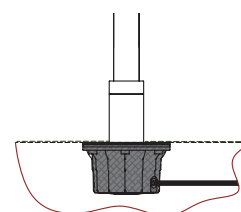



Il piacere di poter usare una illuminazione completa nel giardino di questa villa in particolare modo se pensiamo che il suo consumo è irrisorio se paragonato al altre sorgenti luminose.

Progetto: Villa Privata, Modena, Italy
Light Design: Zani Ranzenigo.

Prodotti: Querdik 3 Led 2 watt
luce fredda

Fully lighting the garden of this home is a pleasure, in particular considering that its energy-consumption is very low compared to other light sources.

*Project: private home, Modena, Italy
Light Design: Zani Ranzenigo.*

Products used: Querdik 3 Leds 2 watt cold light

Le plaisir de pouvoir utiliser un éclairage complet dans le jardin de cette villa, notamment si l'on pense à sa consommation qui est dérisoire comparée à d'autres sources lumineuses.

*Projet: Maison Privée, Modena, Italie
Light Design: Zani Ranzenigo.*

Produits: Querdik 3 Leds 2 watts lumière froide

El placer de poder utilizar una iluminación completa en el jardín de este chalet, en especial si se piensa que su consumo es insignificante si lo comparamos con otras fuentes luminicas.

*Proyecto: Villa particular, Modena, Italia
Light Design: Zani Ranzenigo.*

Productos: Querdik 3 leds 2 watt luz fría

Das Vergnügen, den Garten dieser Villa vollständig beleuchten zu können, ist umso größer, wenn man an den im Vergleich zu anderen Lichtquellen lächerlich geringen Verbrauch denkt.

*Projekt: Privatvilla - Modena - Italien
Lighting Design: Zani Ranzenigo.*

Produkte: Querdik 3 led 2 Watt Kaltlicht



Elop

Amdam

Adren

Elop - Amdam - Adren

Aparato con perfil cuadrado con ópticas basculantes independientes a única emisión. Estructura en aluminio.

Leuchte mit quadratischem Profil mit Schwingoptiken, die voneinander unabhängig sind, mit Einzelemission. Aluminiumstruktur.

Corpo illuminante a profilo quadro con ottiche basculanti indipendenti tra loro a singola emissione. Struttura in alluminio.

Square frame spotlight with adjustable, independent and single emission optics. Aluminium case.

Balise à profil carré avec optiques basculantes indépendant à Émission simple. Structure en Aluminium

Elop	G	2 Watt	1 Watt
		2 LED	2 LED
		85581	85580

Amdam	G	2 Watt	1 Watt
		2 LED	2 LED
		85585	85584

Adren	G	2 Watt	1 Watt
		2 LED	2 LED
		85593	85592

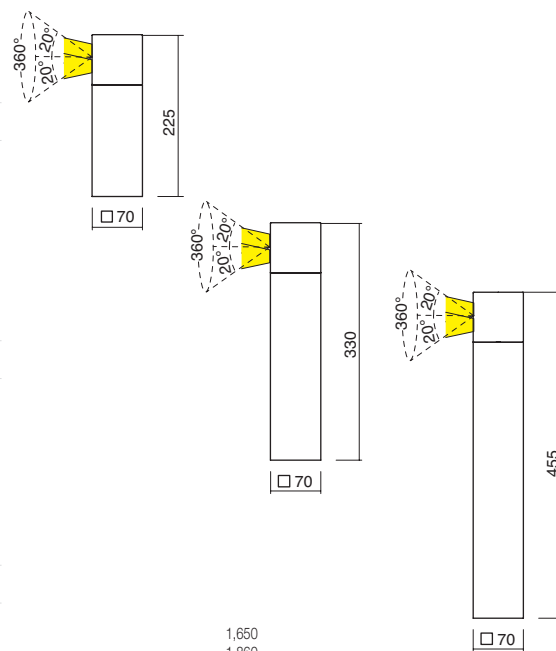

Driver compreso

Driver included
Driver compris
Driver incluido
inklusive Driver

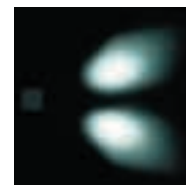

600 mA 350mA

2 WATT POWER 1 WATT POWER

1,650 1,860 2,000

Opticals	code	Colours
10°	10	C
30°	30	W
50°	50	N
70°	70	B
120°	12	Y
		R
		G



OUTSIDE floor

Elop - Amdam - Adren

- living outside



Elop - Amdam - Adren

Corpo illuminante a profilo quadro con ottiche basculanti indipendenti tra loro a doppia emissione. Struttura in alluminio.

Square frame spotlight with adjustable, independent and double emission optics. Aluminium case.

Balise à profil carré avec optiques basculantes indépendantes à Émission double. Structure en Aluminium

Aparato con perfil cuadrado con ópticas basculantes independientes a doble emisión. Estructura en aluminio.

Leuchte mit quadratischem Profil mit Schwingoptiken, die voneinander unabhängig sind, mit Doppelsonnenstrahlung. Aluminiumstruktur.



Elop



Amdam



Adren

Driver compreso

Driver included
Driver compris
Driver incluido
inklusive Driver

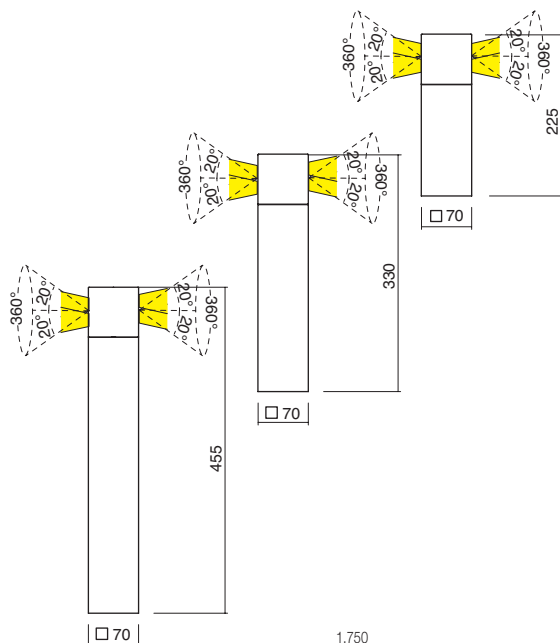
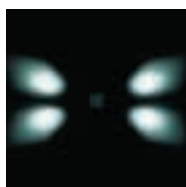

1 Watt 2 Watt

2+2 LED 2+2 LED

85522

85523

G

Elop

1 Watt 2 Watt

2+2 LED 2+2 LED

85588

85589

G

Amdam

1 Watt 2 Watt

2+2 LED 2+2 LED

85596

85597

G

Adren



1,750

1,950

2,100

350mA

600 mA

1 WATT

2 WATT

POWER

POWER

Colours

Opticals code



C

10°

10



W

30°

30



N

50°

50



B

70°

70



Y

120°

12



R



G

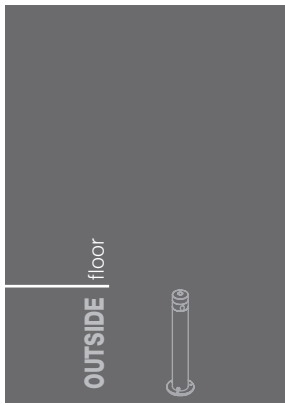

OUTSIDE floor

Querdik



Aparato cilíndrico para exterior con ópticas inclinadas. Estructura en aluminio.

Zylinderförmige Leuchte für Außenräume mit geneigten Optiken. Aluminiumstruktur.

Querdik

Corpo illuminante da esterni cilindrico con ottiche inclinate. Struttura in alluminio.

Outdoor cylindrical spotlight with sloping optics. Aluminium case.

Spot extérieur cylindrique avec optique inclinée. Structure en Aluminium.

	2 Watt	1 Watt
	3 LED	3 LED
G	85601	85599
Ne	86390	86389
CT	87993	87992
	2 Watt	1 Watt
	3 LED	3 LED
G	85771	85769
Ne	86392	86391
CT	87995	87994
	2 Watt	1 Watt
	3 LED	3 LED
G	86412	86410
Ne	86413	86411
CT	87997	87996

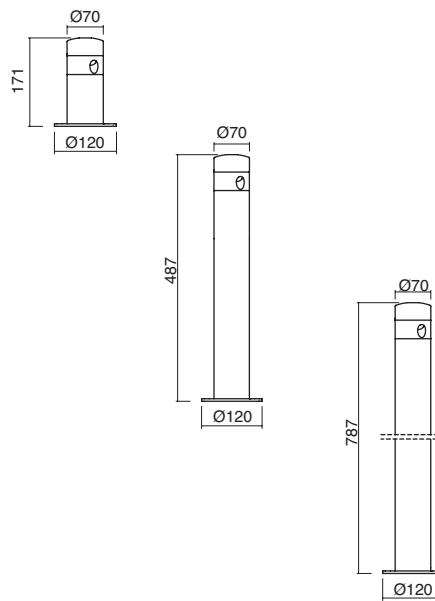

Driver compreso

Driver included
Driver compris
Driver incluido
inklusive Driver

600 mA 350mA 1,160 2,000 2,500

2 WATT POWER 1 WATT POWER

Icons: battery, weight (Kg), no open flame, beam spread, beam angle, F, IP66, ground symbol, CE

Opticals	code	Colours
70°	70	● C
120°	12	● W
		○ N
		● B
		● Y
		● R
		● G

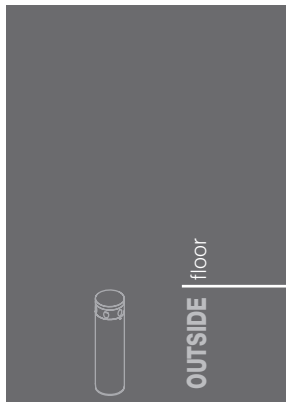

Sequos

- living outside

Sequos

Corpo illuminante da esterni cilindrico da ottiche inclinate. Struttura in alluminio.

Outdoor cylindrical spotlight with sloping optics. Aluminium case.

Spot extérieur cylindrique avec optique inclinée. Structure en Aluminium.

Aparato cilíndrico para exterior con ópticas inclinadas. Estructura en aluminio.

Zylinderförmige Leuchte für Außenräume mit geneigten Optiken. Aluminiumstruktur.



Driver compreso

Driver included
Driver compris
Driver incluido
inklusive Driver

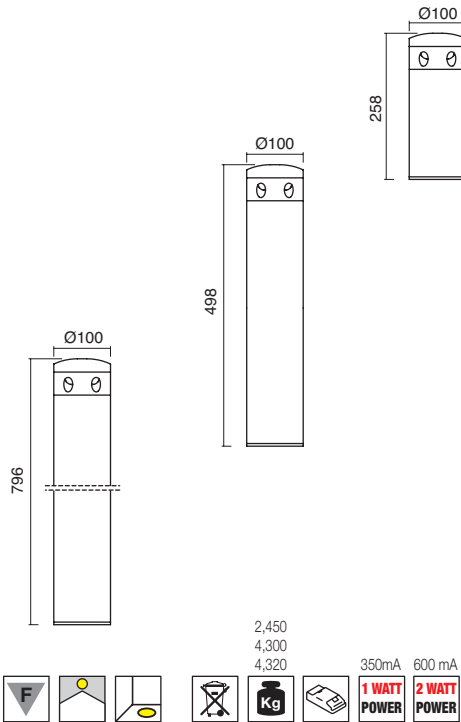

1 Watt	2 Watt	
6 LED	6 LED	
85603	85605	G
86393	86394	Ne
87998	87999	CT
1 Watt	2 Watt	
6 LED	6 LED	
85773	85775	G
86395	86396	Ne
88000	88001	CT
1 Watt	2 Watt	
6 LED	6 LED	
86414	86416	G
86415	86417	Ne
88002	88003	CT

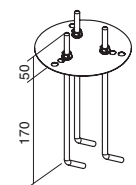

84868

Sistema di fissaggio con tiranti
Draught fixing system
Système de fixation à tirants
Sistema de instalacion con tensores
Zugankerbefestigung

Colours	Opticals	code
● C	70°	70
● W	120°	12
● N		
● B		
● Y		
● R		
● G		

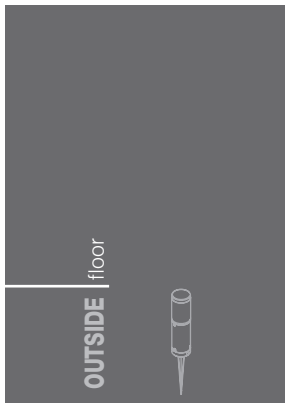

OUTSIDE floor

Andor



Andor

Palo con difusor en polimetilmetacrilato arenado con piquete. Estructura en aluminio.

Pfahl mit Lichtdiffusor aus PMMA, sandbestrahlt auf einem Pflock. Aluminiumstruktur.

Paletto con diffusore in polimetilmetacrilato sabbato su picchetto. Struttura in alluminio.

Bollard with sanded polymethyl methacrylate (PMMA) diffuser. Aluminum case with picket.

Balise avec diffuseur en plexiglas dépoli sur piquet. Structure en Aluminium.

2 Watt 1 Watt
1 LED 1 LED

G	87373	87372
Ne	87376	87375
CT	88005	88004

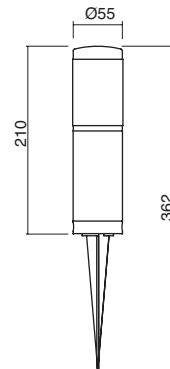

Driver compreso

*Driver included
Driver compris
Driver incluido
inklusive Driver*

87373N00

600 mA 350mA 0,760

Opticals	code	Colours
Diffused	00	<ul style="list-style-type: none"> C W N B Y R G

Picchetto incluso nell'articolo
*Picket included in the item
Piquet fourni avec l'article
Piquete de fijación incluido en el artículo
Der Pflock ist im Artikel eingeschlossen*

Andor

Composizione di paletti con diffusore in polimetilmetacrilato sabbiato su picchetto. Struttura in alluminio. Ideali per creare illuminazioni temporanee su viali, giardini, spiagge.

Composición de palos con difusor en polimetilmetacrilato arenado con piqueta. Estructura en aluminio. Adecuado para crear iluminaciones temporales en avenidas, jardines o playas.

Bollard with picket and sanded polymethyl methacrylate (PMMA) diffusor. Aluminium case, suitable to temporary lighting on gardens, paths and beach.

Zusammensetzung der Pfähle mit Lichtdiffusor aus PMMA, sandbestrahlt auf Pflock. Aluminiumstruktur. Ideal für die Erzeugung von zeitweiliger Beleuchtung in Alleen, in Gärten, auf Stränden.

Composition de balise avec diffuseur en plexiglas dépoli sur piquet. Structure en Aluminium. Adapté pour créer rapidement un éclairage sur chemin, jardin, plage.



Driver compreso

Driver included
Driver compris
Driver incluido
inklusive Driver

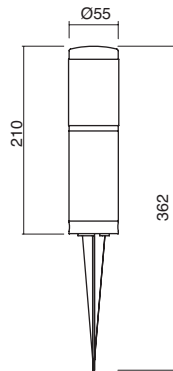

12 SPOT 12 SPOT

1 Watt **2 Watt**

1 LED **1 LED**

87378	87379	G
87381	87382	Ne
88006	88007	CT

Colours Opticals code

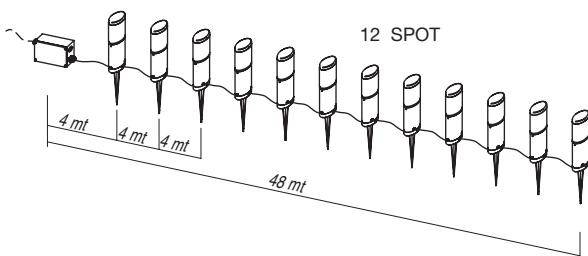

Picchetto incluso nell'articolo
Picket included in the item
Piquet fourni avec l'article
Piquete de fijación incluido en el artículo
Der Pflock ist im Artikel eingeschlossen

- C
- W
- N
- B
- Y
- R
- G

Diffused **00**

OUTSIDE floor



Aron



Aron

Palo con difusor en polimetilmetacrilato arenado con base de fijación. Estructura en aluminio.

Pfahl mit Lichtdiffusor aus PMMA, sandbestrahlt mit Befestigungsbasis. Aluminiumstruktur.

Paletto con diffusore in polimetilmetacrilato sabbiato con base di fissaggio. Struttura in alluminio.

Bollard with sanded polymethyl methacrylate (PMMA) diffuser and fixing base. Aluminium case.

Balise avec diffuseur en plexiglas dépoli avec base de fixation. Structure en Aluminium

	2 Watt	1 Watt
	1 LED	1 LED
G	87391	87390
Ne	87394	87393
CT	88009	88008
	2 Watt	1 Watt
	1 LED	1 LED
G	87397	87396
Ne	87400	87399
CT	88011	88010
	2 Watt	1 Watt
	1 LED	1 LED
G	87403	87402
Ne	87406	87405
CT	88013	88012

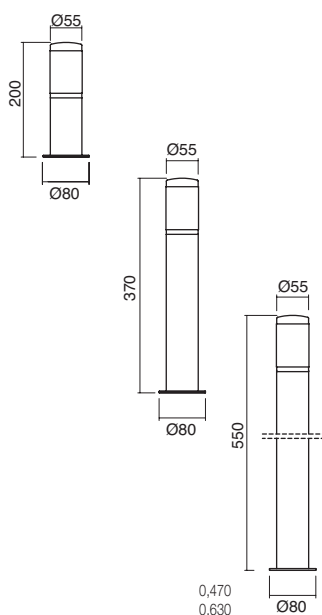

Driver compreso

*Driver included
Driver compris
Driver incluido
inklusive Driver*



Opticals	code	Colours
Diffused	00	<ul style="list-style-type: none"> ● C ● W ● N ● B ● Y ● R ● G

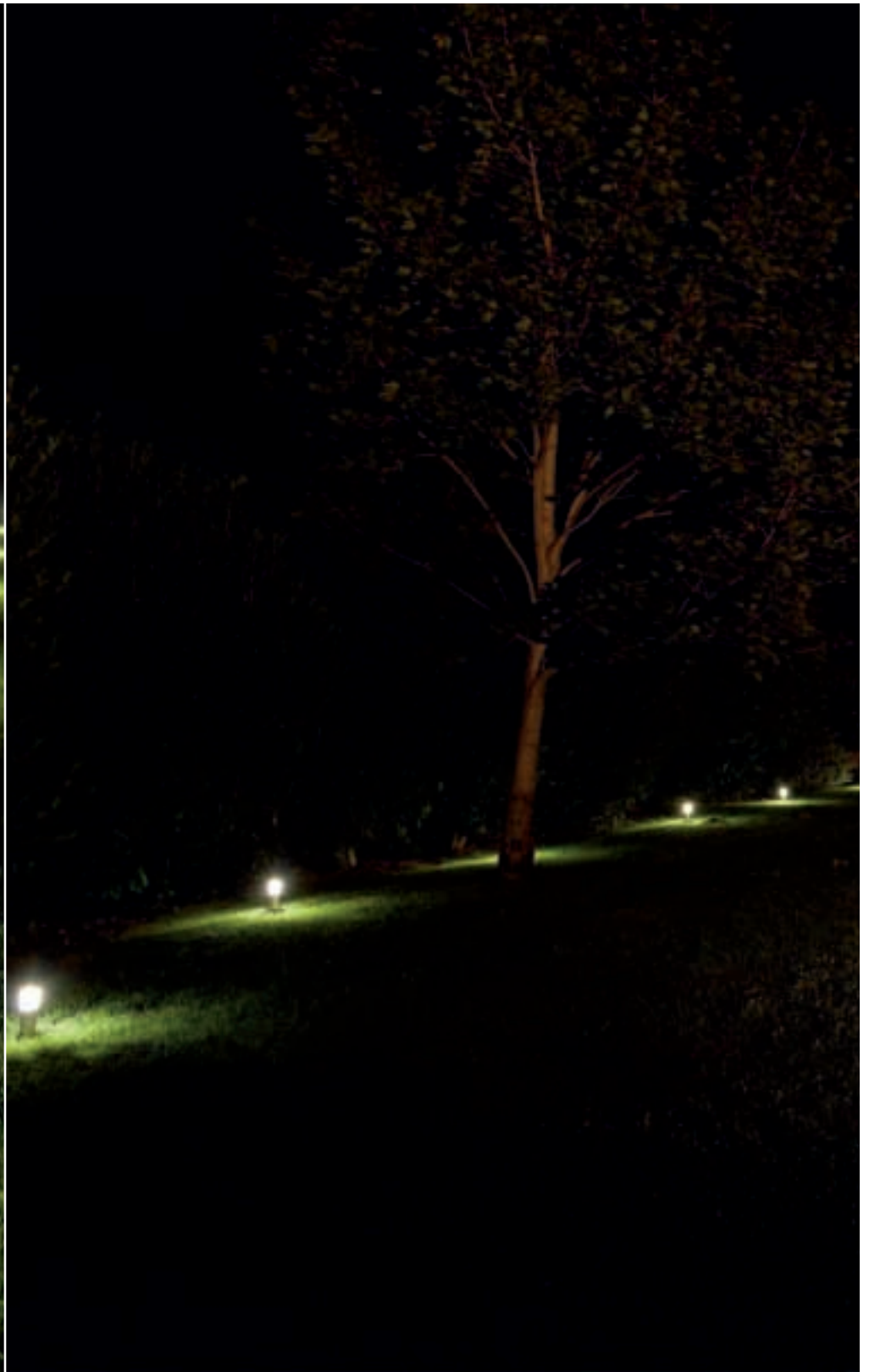

I picchetti, usati singolarmente o in kit da 12 pezzi (max 50 metri di lunghezza), permettono di delineare con molteplici soluzioni i perimetri di giardini o spazi esterni.

Progetto: Abitazione privata - Treviso - Italy
Lighting Design: LineaLight Group

Prodotti: Andor 1 led 2watt 12 pezzi

The pedestal lights, used by themselves or in kits of 12 (maximum 50 metres in length) make it possible to define the perimeters of the garden or of other outdoor spaces in many ways.

Project: private home - Treviso - Italy
Lighting Design: LineaLight Group

Products used: Andor 1 led 2 watt 12 pieces

L'éclairage sur pieds, utilisé en kit de 12 pièces (longueur maxi : 50 mètres), offre de nombreuses solutions pour tracer le contour de jardins ou d'espaces extérieurs.

Projet: maison privée - Trévisé - Italie
Design éclairage: LineaLight Group

Produits: Andor 1 led 2 watts 12 pièces

Las piquetas, usadas individualmente o en set de 12 unidades (50 metros de largo como máximo), permiten perfilar con múltiples soluciones los perímetros de jardines o espacios exteriores.

Proyecto: Vivienda particular - Treviso - Italia
Lighting Design: LineaLight Group

Productos: Andor 1 led 2 watt 12 unidades

Die einzeln oder im Set zu 12 Stück (max. Länge 50 Meter) eingesetzten Steckleuchten bieten eine Vielzahl von Lichtlösungen für die Markierung der Begrenzungslinien von Gärten oder Außenanlagen.

Projekt: Privates Wohngebäude - Treviso - Italien
Lighting Design: LineaLight Group

Produkte: Andor 1 led 2Watt 12 Stück

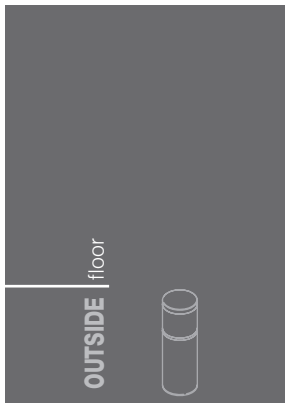

OUTSIDE floor

Albin



Albin

Paletto con diffusore in polimetilmetacrilato sabbato. Struttura in alluminio.

Pillar with sanded polymethyl methacrylate (PMMA) diffuser. Aluminium fixture.

Balise avec diffuseur en plexiglas dépoli. Structure en Aluminium.

Palo con diffusore in polimetilmetacrilato arenado. Estructura en aluminio.

Pfahl mit Lichtdiffusor aus PMMA, sandbestrahlt. Aluminiumstruktur.

	2 Watt	1 Watt
	4 LED	4 LED
G	87409	87408
Ne	87412	87411
CT	88015	88014
	2 Watt	1 Watt
	4 LED	4 LED
G	87415	87414
Ne	87418	87417
CT	88017	88016
	2 Watt	1 Watt
	4 LED	4 LED
G	87421	87420
Ne	87424	87423
CT	88019	88018

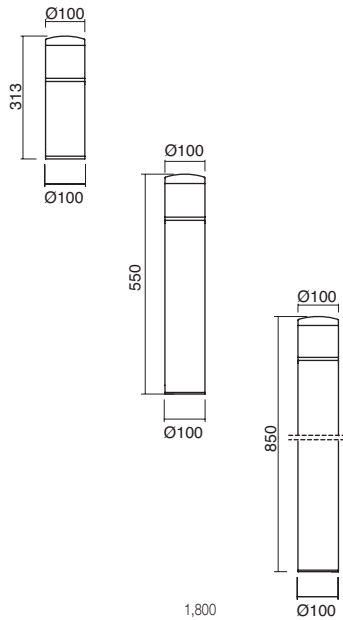

Driver compreso

Driver included
Driver compris
Driver incluido
inklusive Driver

600 mA 350mA
2 WATT POWER **1 WATT POWER** **IP66**

Opticals	code	Colours
Diffused	00	<ul style="list-style-type: none"> C W N B Y R G

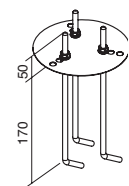

84868

Sistema di fissaggio con tiranti
Draught fixing system
Système de fixation à tirants
Sistema de instalacion con tensores
Zugankerbefestigung

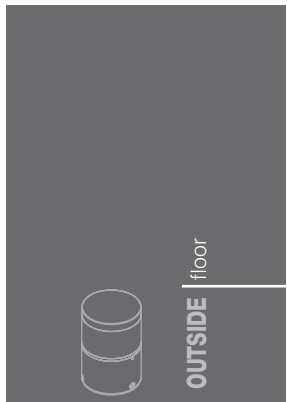

Abel

- living outside

Abel

Paletto con diffusore in polimetilmetacrilato sabbato. Struttura in alluminio.

Pillar with sanded polymethyl methacrylate (PMMA) diffusor. Aluminium fixture.

Balise avec diffuseur en plexiglas dépoli. Structure en Aluminium.

Palo con difusor en polimetilmetacrilato arenado. Estructura en aluminio.

Pfahl mit Lichtdiffusor aus PMMA, sandbestraht. Aluminiumstruktur.



Driver compreso

Driver included
Driver compris
Driver incluido
inklusive Driver

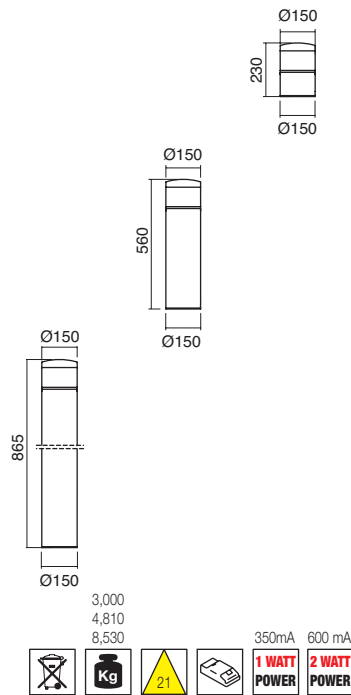

1 Watt	2 Watt	
6 LED	6 LED	
87426	87427	G
87429	87430	Ne
88020	88021	CT
1 Watt	2 Watt	
6 LED	6 LED	
87432	87433	G
87435	87436	Ne
88022	88023	CT
1 Watt	2 Watt	
6 LED	6 LED	
87438	87439	G
87441	87442	Ne
88024	88025	CT

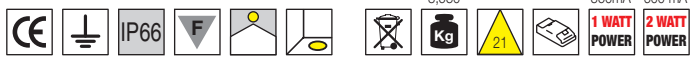

Colours	Opticals	code
● C	Diffused	00
● W		
● N		
● B		
● Y		
● R		
● G		

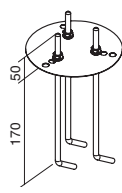

84868
Sistema di fissaggio con tiranti
Draught fixing system
Système de fixation à tirants
Sistema de instalacion con tensores
Zugankerbefestigung

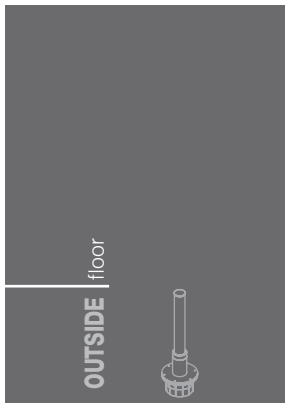

OUTSIDE floor

Isidor

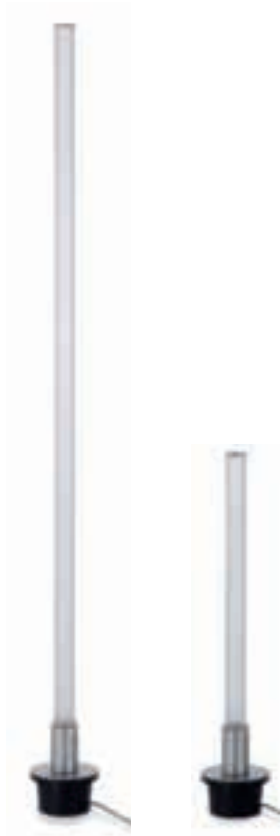

Isidor

Aparato para exterior con difusor en polimetilmetacrilato arenado con base apta para enterrar y para una instalación sencilla y veloz. No necesita operaciones especiales para la instalación.

Leuchte für Außenräume mit Lichtdiffusor aus PMMA, sandbestrahlt mit Basis, die versenkt werden kann, für eine einfache und schnelle Installation. Es sind keine besonderen Installationsarbeiten notwendig.

Corpo illuminante da esterni con diffusore in polimetilmetacrilato sabbato con base atta ad essere interrata per una semplice e veloce installazione. Non necessita di particolari opere per l'installazione

Outdoor spotlight with sanded polymethyl methacrylate (PMMA) diffuser and fixing base suitable to a simple and rapid installation.

Phare pour extérieur avec diffuseur en plexiglas dépoli avec base pouvant être enterré pour une rapide et simple installation. Ne nécessite aucune manipulation particulière pour l'installation.

2 Watt

3 LED

G

87851

2 Watt

3 LED

G

87852

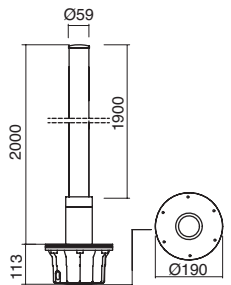
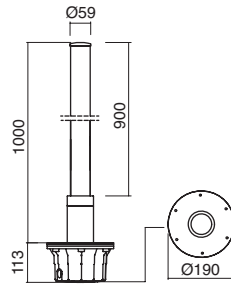

Driver compreso

Driver included
Driver compris
Driver incluido
inklusive Driver



Opticals	code	Colours
Diffused	00	<ul style="list-style-type: none"> ● C ● W ● N ● B ● Y ● R ● G

Controcassa inclusa nell'articolo
Outer casing included in the item
Boîtier fourni avec l'article
Contracaja incluida en el artículo
Das Montagegehäuse ist im Artikel eingeschlossen

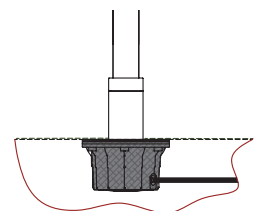



Singolare elemento di decoro per ambienti esterni o interni, emanando una luce attrattiva, delinea percorsi e valorizza l'ambiente circostante. Di facile installazione grazie alla posa diretta a terra tramite apposita controcassa.

An original decor element for indoor or outdoor use, it creates an attractive light, marks off paths and sets off the surrounding environment. It is easy to install because it is positioned directly on the ground in a counterhousing.

Éléments particuliers de décoration pour ambiances extérieures ou intérieures, produisant une lumière attractive, pouvant être utilisés pour tracer des parcours et mettant en valeur l'ambiance environnante. Facilité d'installation grâce à leur pose directe au sol au moyen de logements spéciaux.

Singular elemento de decoración para ambientes exteriores o interiores, emitiendo una luz atractiva señala los caminos y realza el entorno. De fácil instalación gracias a la colocación directa en el suelo mediante caja de conexión expresa.

Ungewöhnliches Dekorelement für Innen- und Außenbereiche, das ein attraktives Licht verbreitet, Wege umreißt und das umliegende Ambiente aufwertet. Dank einer eigens dafür vorgesehenen Bodeneinbaudose wird diese Leuchte einfach im Boden installiert.

Progetto: Ricostruzione
Lighting Design: Linealight Group

Project: Reconstruction
Lighting Design: Linealight Group

Projet: Reconstruction
Design éclairage: Linealight Group

Proyecto: Restauración
Lighting Design: Linealight Group

Projekt: Wiederaufbau
Lighting Design: Linealight Group

Prodotti: Isidor 3 Led 2 Watt RGB

Products used: Isidor 3 Leds 2 Watt RGB

Produits: Isidor 3 Leds 2 Watt RGB

Productos: Isidor 3 leds 2 watt RGB

Produkte: Isidor 3 Led 2 Watt RGB

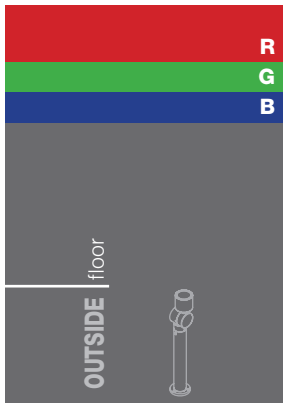

Cyga



Cyga

Corpo illuminante per esterni con faretto regolabile. Struttura interamente in alluminio.

Outdoor pillar with adjustable spotlight. Full aluminium structure.

Petit poteau avec spot réglable pour extérieur. Structure entièrement en Aluminium.

Aparato para exterior con foco regulable y estructura enteramente en aluminio.

Leuchte für Außenräume mit einstellbarer Leuchte. Struktur ganz aus Aluminium.

2 Watt RGB 1 Watt RGB

3 LED 3 LED

G	85467	85466
----------	-------	-------

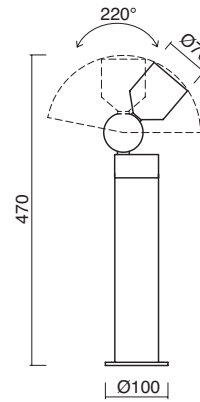

Driver NON compreso

Driver not included
Driver non compris
Driver no incluido
exklusive Driver

vedi cap. Driver RGB
See RGB Driver section
Voi chapitre RGB Drivers
Ver capitolo Driver RGB
siehe Kap. "RGB Driver"

600mA 350mA 1,000 1,260

Opticals	code	Colours
10°	10	z
30°	30	
50°	50	
70°	70	
120°	12	

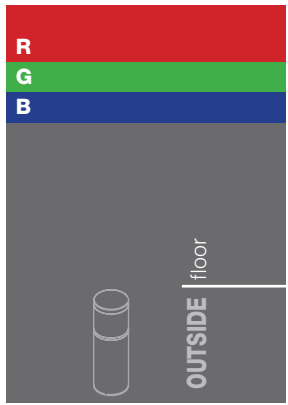

Albin

- living outside

Albin

Paletto con diffusore in polimetilmetacrilato sabbato. Struttura in alluminio.

Pillar with sanded polymethyl methacrylate (PMMA) diffuser. Aluminium fixture.

Balise avec diffuseur en plexiglas dépoli. Structure en Aluminium.

Palo con difusor en polimetilmetacrilato arenado. Estructura en aluminio.

Pfahl mit Lichtdiffusor aus PMMA, sandbestraht. Aluminiumstruktur.



Driver NON compreso

Driver not included
Driver non compris
Driver no incluido
exklusive Driver

vedi cap. Driver RGB
See RGB Driver section
Voir chapitre RGB Drivers
Ver capitolo Driver RGB
siehe Kap. "RGB Driver"

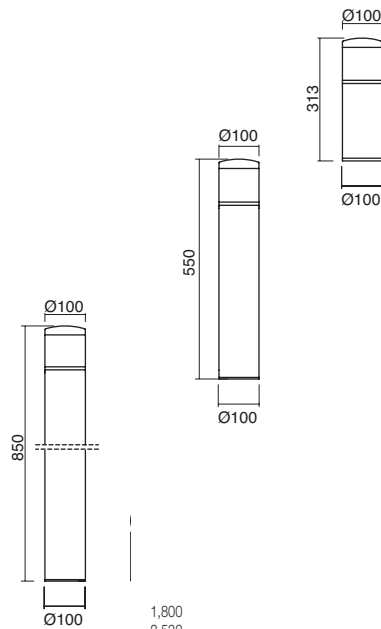

1 Watt RGB

6 LED

87410	G
87413	Ne
88026	CT

1 Watt RGB

6 LED

87416	G
87419	Ne
88027	CT

1 Watt RGB

6 LED

87422	G
87425	Ne
88028	CT

Colours



Z

Opticals code

Diffused

00

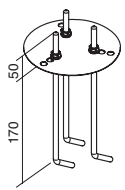

84868

Sistema di fissaggio con tiranti
Draught fixing system
Système de fixation à tirants
Sistema de instalacion con tensores
Zugankerbefestigung

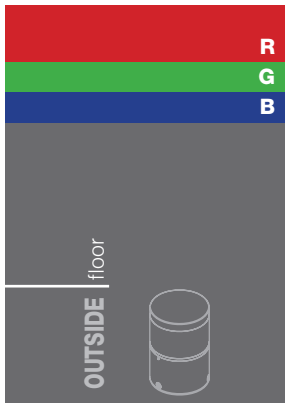

Abel



Palo con diffusor en polimetilmetacrilato arenado. Estructura en aluminio.

Pfahl mit Lichtdiffusor aus PMMA, sandbestrahlt. Aluminiumstruktur.

Abel

Paletto con diffusore in polimetilmetacrilato sabbato in alluminio.

Pillar with sanded polymethyl methacrylate (PMMA) diffusor. Aluminium fixture.

Balise avec diffuseur en plexiglas dépoli. Structure en Aluminium.

2 Watt RGB

6 LED

G	87428
Ne	87431
CT	88029

2 Watt RGB

6 LED

G	87434
Ne	87437
CT	88030

2 Watt RGB

6 LED

G	87440
Ne	87443
CT	88031

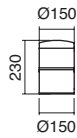

600mA

2 WATT
R G B

Driver NON compreso

*Driver not included
Driver non compris
Driver no incluido
exklusive Driver*

*vedi cap. Driver
See Driver section
Voir chapitre Drivers
Ver capitulo Driver
siehe Kap. "Driver"*

Opticals	code	Colours
Diffused	00	z

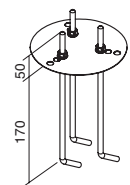

84868

Sistema di fissaggio con tiranti
*Draught fixing system
Système de fixation à tirants
Sistema de instalacion con tensores
Zugankerbefestigung*

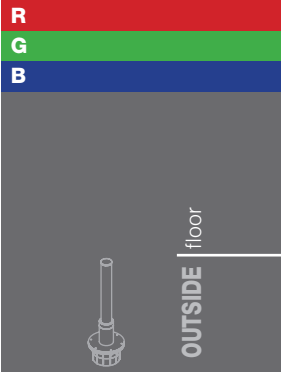

Isidor

Isidor

Corpo illuminante da esterni con diffusore in polimetilmetacrilato sabbato con base atta ad essere interrata per una semplice e veloce installazione. Non necessita di particolari opere per l'installazione

Outdoor spotlight with sanded polymethyl methacrylate (PMMA) diffuser and fixing base suitable to a simple and rapid installation.

Phare pour extérieur avec diffuseur en plexiglas dépoli avec base pouvant être enterré pour une rapide et simple installation. Ne nécessite aucune manipulation particulière pour l'installation.

Aparato para exterior con difusor en polimetilmetacrilato arenado con base apta para enterrar y para una instalación sencilla y veloz. No necesita operaciones especiales para la instalación.

Leuchte für Außenräume mit Lichtdiffusor aus PMMA, sandbestrahlt mit Basis, die versenkt werden kann, für eine einfache und schnelle Installation. Es sind keine besonderen Installationsarbeiten notwendig.



Driver NON compreso

Driver not included
Driver non compris
Driver no incluido
exklusive Driver

vedi cap. Driver
See Driver section
Voir chapitre Drivers
Ver capitolo Driver
siehe Kap. "Driver"

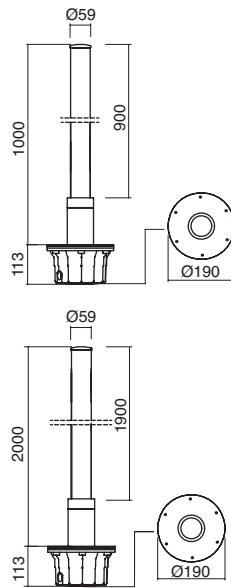

2 Watt RGB

3 LED

87854

G

2 Watt RGB

3 LED

87855

G

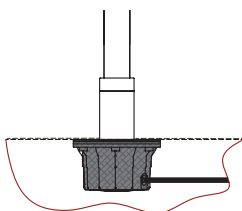
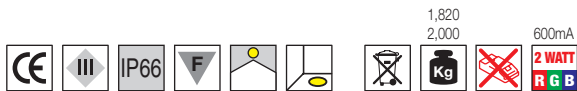

Controcassa inclusa nell'articolo

Outer casing included in the item
Boîtier fourni avec l'article
Contracaja incluida en el artículo
Das Montagegehäuse ist im Artikel eingeschlossen

Colours



Opticals code

Diffused 00

- living outside

