

CAP14

è - living inside

è - living outside

Applique a emissione singola o doppia da 1 a 12 leds, 1 e 2 watt, versatili si prestano ad installazioni verticali e orizzontali creando effetti scenografici su pareti e soffitti. La versatilità delle diverse ottiche consente di far risaltare la dimensione e la profondità degli spazi. Plafoniere ad ottica basculante per uso esterno nel massimo rispetto dei vincoli architettonici.

Single or double-beam wall lights with 1 to 12 leds, 1 and 2 watt. They are versatile and suitable for vertical and horizontal installations to create spectacular effects on the wall and ceiling. The versatility of the various optic lenses allows you to stress the dimensions and depths of spaces. The directional optical lens downlights for outdoor use respect architectural structures to the utmost degree.

Applique à émission simple ou double, ayant de 1 à 12 leds, 1 et 2 watts. Éléments versatiles se prêtant à des installations verticales ou horizontales et créant des effets décoratifs sur les parois et aux plafonds. La versatilité des différentes lentilles optiques permet de faire ressortir la dimension et la profondeur des espaces. Des plafonniers avec lentille optique basculante pour usage à l'extérieur, respectant au maximum les contraintes architecturales.

Apliques con emisión individual o doble de 1 a 12 leds, 1 y 2 watt, versátiles que se prestan a instalaciones verticales y horizontales creando efectos escenográficos en paredes y techos. La versatilidad de las distintas ópticas realza el tamaño y la profundidad de los espacios. Plafones de techo con óptica basculante para uso exterior respetando al máximo los vínculos arquitectónicos.

Wand- und Deckenleuchten mit einfachem oder zweifachem Lichtaustritt, 1 - 12 LED 1 und 2 Watt die senkrecht oder waagrecht montiert werden können. Sie schaffen eindrucksvolle Lichteffekte auf Wand- und Deckenflächen. Die Vielseitigkeit der einzelnen Optiken hebt die Dimensionen der Räume hervor. Deckenleuchten mit schwenkbarem Lichtaustritt ermöglichen alle architektonischen Vorgaben speziell auch im Außenbereich.

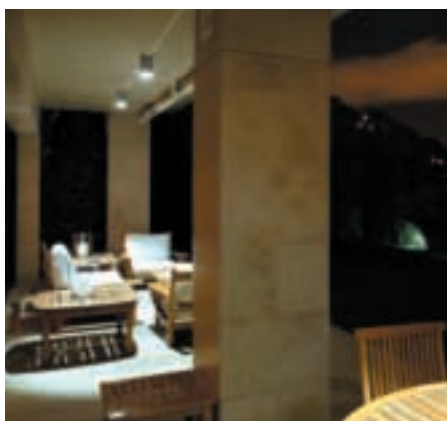

Abitazione Privata - Catalonia. Un'illuminazione adeguata di terrazze o verande può accrescere la suggestione dell'esterno. Ativ 6led x 2 watt. Private home - Catalonia. The right lighting of terraces and porches can increase the appeal of exteriors. Ativ 6led x 2 watt. / Habitation privée - Catalogne. Un éclairage approprié sur les terrasses et les vérandas peut rendre le décor extérieur plus suggestif. Ativ 6 leds x 2 watts. / Vivienda particular - Cataluña. La iluminación adecuada de balcones o porches puede potenciar la sugestión del exterior. Ativ 6 leds x 2 watt. / Privates Wohngebäude - Catalonia - Die passende Beleuchtung von Terrassen oder Veranden kann die Faszination des Außenbereichs verstärken. Ativ 6 led x 2 watt.

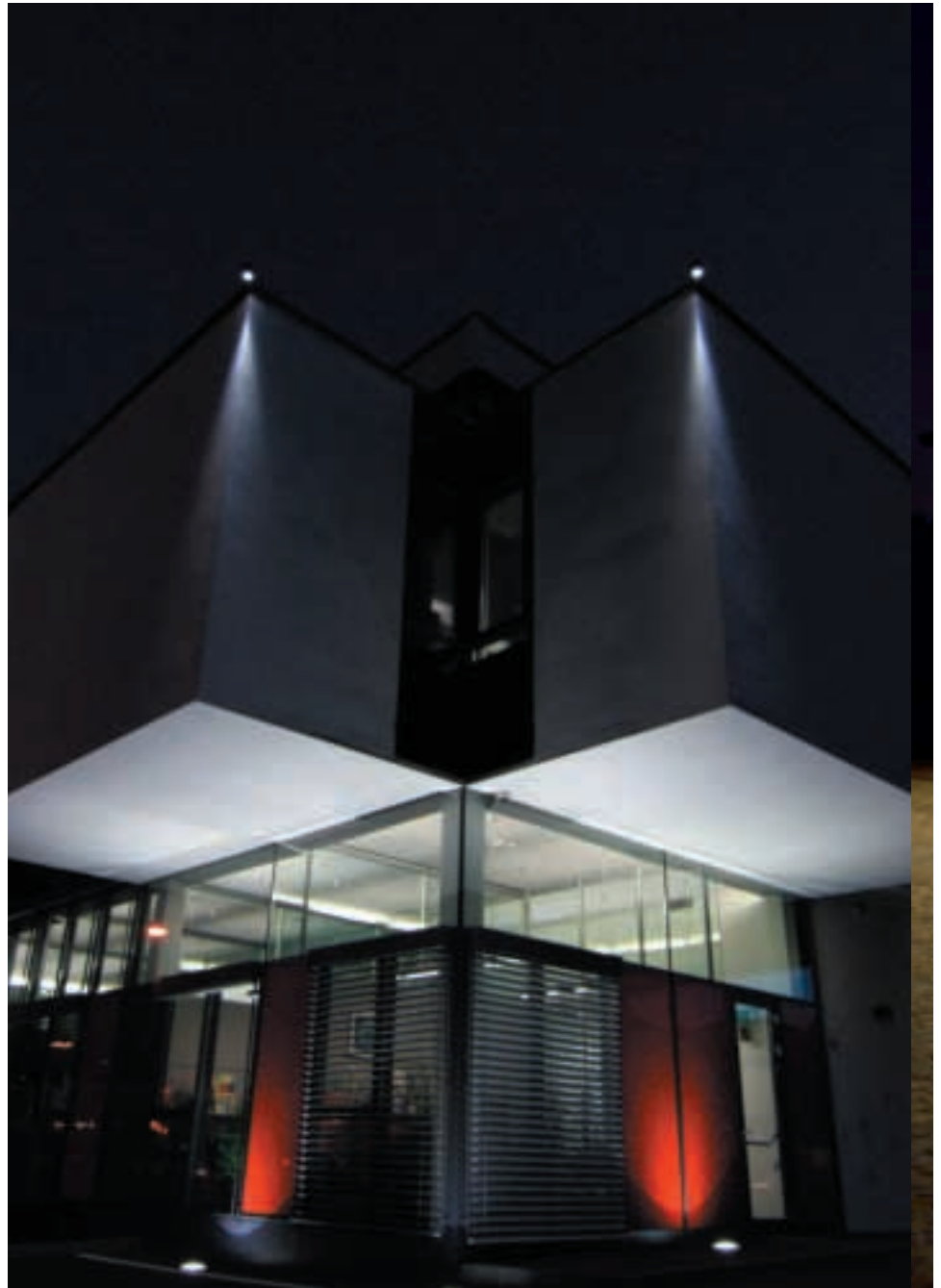

Vienna - Struttura Commerciale. I profili della particolare forma architettonica vengono evidenziati da una suggestiva illuminazione a led. Elix 6 led 2 watt. / Vienna - Office building - The framework of the original architectural structure is set off by eye-catching led lighting. Elix 6 leds 2 watt. / Vienne - Structure commerciale. Les profils de la forme architecturale particulière sont mis en évidence par un éclairage à leds. Elix 6 leds 2 watts. / Viena - Establecimiento comercial. Los perfiles de la particular forma arquitectónica son evidenciados por la sugerente iluminación de leds. Elix 6 leds 2 watt. / Wien - Bürogebäude. Die Umrisse der ungewöhnlichen architektonischen Form werden durch eine stimmungsvolle led - Beleuchtung betont. Elix 6 led2 watt.



Diffusione laterale per un effetto anti-abbagliante, sufficiente e funzionale per rendere più agevole l'entrata nella zona di parcheggio.

Progetto: Villa privata - Treviso - Italy
Lighting Design: LineaLight Group

Prodotti: Algot 4 led 2watt

Lateral diffusion for an anti-glaring and functional effect in order to make parking easier.

*Project: Private Home - Treviso - Italy
Lighting Design: Linea Light Group*

Products used: Algot 4 leds 2 watt

Diffusion latérale pour un effet anti-éblouissement, suffisante et fonctionnelle pour rendre plus agréable l'accès à la zone parking.

*Projet: Villa privée, Trévis, Italie
Design éclairage : Linea Light Group*

Produits : Algot 4 leds 2 watts

Difusión lateral para un efecto antideslumbrante, suficiente y funcional para facilitar la entrada en la zona de estacionamiento.

*Proyecto: Chalet particular - Treviso - Italia
Lighting Design: LineaLight Group*

Productos: Algot 4 leds 2 watt

Seitliche Streuung für eine ausreichende und zweckmäßige Blendschutzwirkung, um den Eintritt in den Parkbereich bequemer zu gestalten.

*Projekt: Privatvilla - Treviso - Italien
Lighting Design: LineaLight Group*

Produkte: Algot 4 led 2 Watt

INSIDE
OUTSIDE

ceiling



Ginny



Plafòn con òptica basculante para exterior (IP65) y hecho enteramente en aluminio.

Deckenleuchte mit schwenkbarem Lichtaustritt zur Anwendung im Außenbereich.

Ginny

Corpo illuminante da soffitto a ottica basculante per uso esterno (IP65). Interamente in alluminio.

Ceiling outdoor spotlight with adjustable optic, IP65 and aluminium case.

Spot pour plafond avec optique basculante pour utilisation en extérieur IP65 entièrement en Aluminium.

1 Watt

3 LED

G

85362

1 Watt

3 LED

G

85363

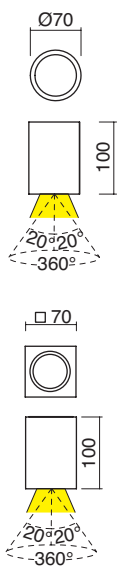

Driver compreso

Driver included
Driver compris
Driver incluido
inklusive Driver



Opticals	code	Colours
10°	10	C
30°	30	W
50°	50	N
70°	70	B
120°	12	Y
		R
		G

Ginny

Corpo illuminante da soffitto a ottica basculante per uso esterno (IP65). Interamente in alluminio.

Ceiling outdoor spotlight with adjustable optic, IP65 and aluminium case.

Spot pour plafond avec optique basculante pour utilisation en extérieur IP65 entièrement en Aluminium.

Plafòn con òptica basculante para exterior (IP65) y hecho enteramente en aluminio.

Deckenleuchte mit schwenkbarem Lichtaustritt zur Anwendung im Außenbereich.



Driver compreso

Driver included
Driver compris
Driver incluido
inklusive Driver

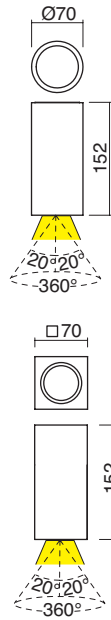

2 Watt

3 LED

85364

G

2 Watt

3 LED

85365

G



Colours	Opticals	code
● C	10°	10
● W	30°	30
● N	50°	50
● B	70°	70
● Y	120°	12
● R		
● G		

- living inside



- living outside



INSIDE
OUTSIDE | ceiling



Ativ



Plafòn con òptica basculante para exterior (IP65) y hecho enteramente en aluminio.

Deckenleuchte mit schwenkbarem Lichtaustritt zur Anwendung im Außenbereich.

Ativ

Corpo illuminante da soffitto a ottica basculante per uso esterno (IP65). Interamente in alluminio.

Ceiling outdoor spotlight with adjustable optic, IP65 and aluminium case.

Spot pour plafond avec optique basculante pour utilisation en extérieur IP65 entièrement en Aluminium

1 Watt

6 LED

G

85370

1 Watt

6 LED

G

85371

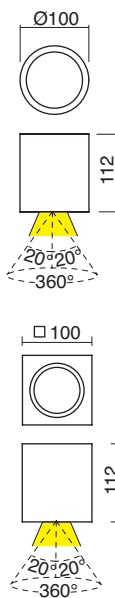

Driver compreso

Driver included
Driver compris
Driver incluido
inklusive Driver



Opticals	code	Colours
10°	10	C
30°	30	W
50°	50	N
70°	70	B
120°	12	Y
		R
		G



INSIDE
OUTSIDE ceiling

Ativ

Ativ

Corpo illuminante da soffitto a ottica basculante per uso esterno (IP65). Interamente in alluminio.

Ceiling outdoor spotlight with adjustable optic, IP65 and aluminium case.

Spot pour plafond avec optique basculante pour utilisation en extérieur IP65 entièrement en Aluminium

Plafòn con òptica basculante para exterior (IP65) y hecho enteramente en aluminio.

Deckenleuchte mit schwenkbarem Lichtaustritt zur Anwendung im Außenbereich.



Driver compreso

Driver included
Driver compris
Driver incluido
inklusive Driver

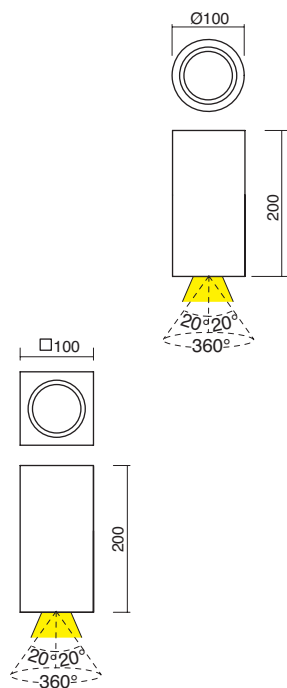

2 Watt

6 LED

85372

G

2 Watt

6 LED

85373

G



Colours	Opticals	code
C	10°	10
W	30°	30
N	50°	50
B	70°	70
Y	120°	12
R		
G		

- living inside



- living outside





Algot



Algot

Aparato para aplicación a pared o a techo con difusor en polimetilmetacrilato, arenado internamente. Protección frontal en acero inox para recrear una emisión indirecta. Cuerpo en aluminio.

Corpo illuminante da parede o da sofitto con difusore in polimetilmetacrilato con interno sabbato. Protezione frontale in acciaio inox per ricreare un' emissione indiretta. Corpo in alluminio.

Wand- und Deckenleuchte mit Diffusor aus PMMA innen satiniert. Frontabdeckung aus Edelstahl, indirekter Lichtaustritt.

Wall and ceiling light with polymethyl methacrylate diffuser with sanded interior. Steel frontal protection for indirect emission. Aluminium case.

Spot à pari ou plafond avec diffuseur en plexiglas dépoli de intérieur Protection frontal en Inox pour créer un émission direct. Corps en Aluminium.

Driver compreso

Driver included
Driver compris
Driver incluido
inklusive Driver

2 Watt 1 Watt
4 LED 6 LED

G 87444 87445

2 Watt 1 Watt
4 LED 6 LED

G 87447 87448

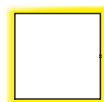
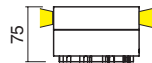
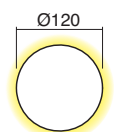
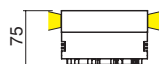

Opticals	code	Colours
Diffused	00	<ul style="list-style-type: none"> ● C ● W ● N ● B ● Y ● R ● G



INSIDE OUTSIDE ceiling | wall

Algot

Algot

Corpo illuminante da parete o da soffitto con diffusore in polimetilmetacrilato con interno sabbciato ed esterno lucido. Corpo in alluminio.

Wall and ceiling light with polymethyl methacrylate diffuser with sanded interior and bright exterior. Aluminium case.

Spot à paroi ou plafond avec diffuseur en plexiglas dépoli de intérieur et translucide en extérieur. Corps en Aluminium.

Aparato para aplicación a pared o a techo con difusor polimetilmetacrilato, satinado y arenado internamente, lúcido externamente. Cuerpo hecho en aluminio.

Wand- oder Deckenleuchte mit Diffusor aus PMMA innen satiniert und hochglänzendem Gehäuse.



Driver compreso

Driver included
Driver compris
Driver incluido
inklusive Driver

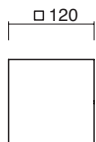
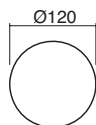

1 Watt 2 Watt

6 LED 4 LED

87858 87857

G

1 Watt 2 Watt

6 LED 4 LED

87861 87860

G

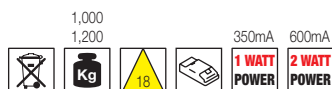

Colours Opticals code

- C
- W
- N
- B
- Y
- R
- G

Diffused 00

- living inside

- living outside



INSIDE
OUTSIDE

ceiling



Blixt



Blixt

*Aplicque con doble emisión,
e luz indirecta. Hecho
enteramente en aluminio.*

*Wandleuchte
indirekt strahlend.
Ganz aus Aluminium.*

**Corpo illuminante da
parete ad emissione
doppia e luce indiretta.
Interamente in alluminio**

*Wall spot with double-
emission and indirect light;
full aluminium.*

*Applique à émission
double et lumière indirect.
entièrément en Aluminium.*

2 Watt

2+1 LED

G

87950

CT

87960

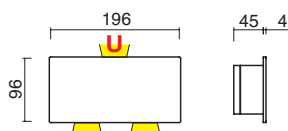

2 Watt

2+2 LED

G

87951

CT

87961

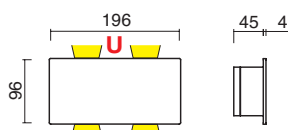

Driver compreso

*Driver included
Driver compris
Driver incluido
inklusive Driver*



Opticals	code	Colours
10°	10	● C
30°	30	● W
50°	50	○ N
70°	70	● B
120°	12	● Y
Wall Washer 25°	25	● R
		● G

Esempio comp. codice

*Example of code composition
Exemple comp. codes
Ejemplo de comp. del código
Beispiel Code-
Zusammensetzung*

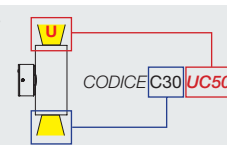



Cortile adeguatamente illuminato attraverso una luce diffusa che consente di vivere lo spazio esterno in piena libertà e comfort.

Progetto: Villa privata - Treviso - Italy
Lighting Design: LineaLight Group

Prodotti: Algot 4led 2watt

Courtyard suitably lit by means of a diffused light that allows you to use the outdoor space in full freedom and comfort.

*Project: Private Home - Treviso - Italy
Lighting Design: Linea Light Group*

Products used: Algot 4 leds 2 watt

Éclairage extérieur effectué grâce à une lumière diffuse permettant de profiter de l'espace extérieur en toute liberté et avec un confort maximum.

*Projet : Villa privée, Trévis, Italie
Design éclairage : Linea Light Group*

Produits : Algot 4 leds 2 watts

Patio oportunamente iluminado mediante una luz difusa que consente vivir el espacio exterior con toda libertad y confort.

*Proyecto: Chalet particular - Treviso - Italia
Lighting Design: LineaLight Group*

Productos: Algot 4 leds 2 watt

Angemessene Hofbeleuchtung durch eine diffuse Lichtquelle, die eine uneingeschränkte und sichere Nutzung des Außenbereichs ermöglicht.

*Projekt: Privatvilla - Treviso - Italien
Lighting Design: LineaLight Group*

Produkte: Algot 4 LED 2 Watt

OUTSIDE wall



Ophil



Aplicque con única emisión.
Hecho enteramente en aluminio.

Wandleuchte mit
Einzelemission, ganz aus
Aluminium.

Ophil
Corpo illuminante da
parete ad emissione
singola interamente in
alluminio.

Wall single emission
spotlight, full aluminium.

Applique à émission simple
entièrement en Aluminium

2 Watt **1 Watt**
1 LED **1 LED**

G	85380	85378
CT	88041	88039

2 Watt **1 Watt**
1 LED **1 LED**

G	85381	85379
CT	88042	88040

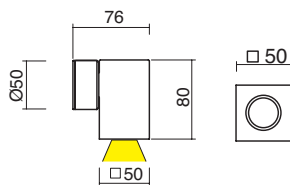
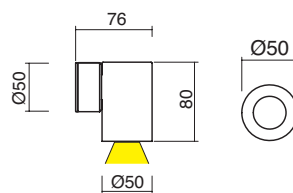

Driver compreso
Driver included
Driver compris
Driver incluido
inklusive Driver

85380N30
85381N30 

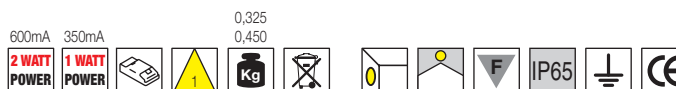

Opticals	code	Colours
10°	10	 C
30°	30	 W
50°	50	 N
70°	70	 B
120°	12	 Y
		 R
		 G



OUTSIDE wall

Atsia

Atsia

Corpo illuminante da parete ad emissione singola interamente in alluminio.

Wall single emission spotlight, full aluminium.

Applique à émission simple entièrement en Aluminium

Aplicque con única emisión. Hecho enteramente en aluminio.

Wandleuchte mit einfachem Lichtaustritt. Ganz aus Aluminium.



Driver compreso

Driver included
Driver compris
Driver incluido
inklusive Driver

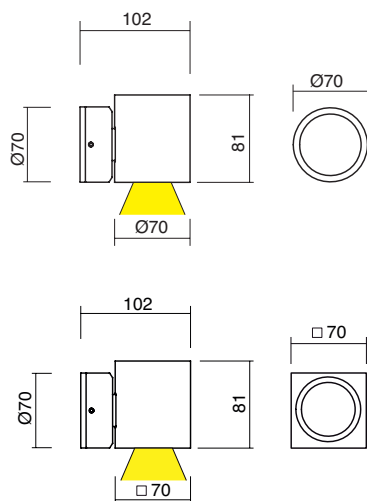

1 Watt

3 LED

85386

G

88043

CT

1 Watt

3 LED

85387

G

88044

CT



85386N30
85387N30



Colours

- C
- W
- N
- B
- Y
- R
- G

Opticals code

- 10° 10
- 30° 30
- 50° 50
- 70° 70
- 120° 12



Elix



*Aplicue con única emisión.
Hecho enteramente en aluminio.*

*Wandleuchte mit einfachem
Lichtaustritt.
Ganz aus Aluminium.*

Elix
Corpo illuminante da parete ad emissione singola interamente in alluminio.

Wall single emission spotlight, full aluminium.

Applique à émission simple entièrement en Aluminium

1 Watt

6 LED

G

85394

CT

88045

1 Watt

6 LED

G

85395

CT

88046

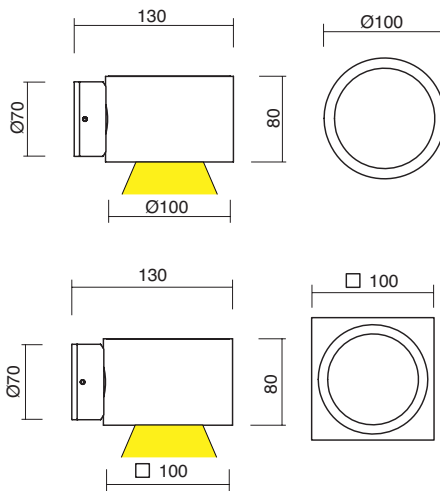

Driver compreso

*Driver included
Driver compris
Driver incluido
inklusive Driver*

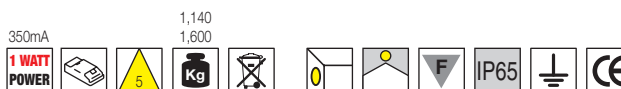

Opticals	code	Colours
10°	10	C
30°	30	W
50°	50	N
70°	70	B
120°	12	Y
		R
		G



OUTSIDE wall

Elix

Elix

Corpo illuminante da parete ad emissione singola interamente in alluminio.

Wall single emission spotlight, full aluminium.

Applique à émission simple entièrement en Aluminium

Aplicque con única emisión. Hecho enteramente en aluminio.

Wandleuchte mit einfachem Lichtaustritt. Ganz aus Aluminium.



Driver compreso

Driver included
Driver compris
Driver incluido
inklusive Driver

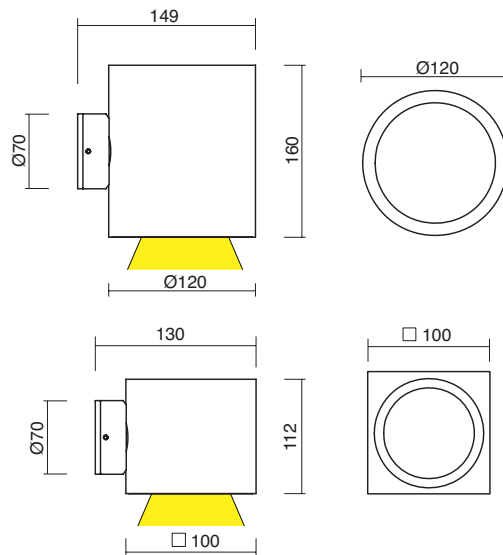

2 Watt

6 LED

85398

G

88047

CT

2 Watt

6 LED

85399

G

88048

CT

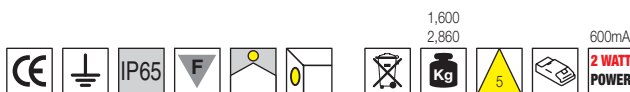

Colours	Opticals	code
● C	10°	10
● W	30°	30
● N	50°	50
● B	70°	70
● Y	120°	12
● R		
● G		

- living outside



OUTSIDE wall



Decos



Decos

*Aplicue con única emisión.
Hecho enteramente en aluminio.*

*Wandleuchte mit einfachem
Lichtaustritt.
Ganz aus Aluminium.*

Corpo illuminante da parete ad emissione singola interamente in alluminio.

Wall single emission spotlight, full aluminium.

Applique à émission simple entièrement en Aluminium

	2 Watt	1 Watt
	12 LED	12 LED
G	85410	85406

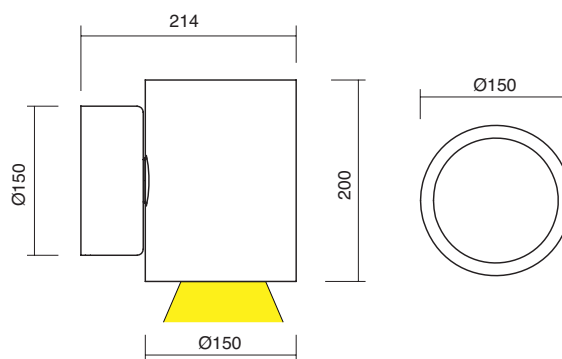

Driver compreso
*Driver included
Driver compris
Driver incluido
inklusive Driver*



Opticals	code	Colours
10°	10	● C
30°	30	● W
50°	50	○ N
70°	70	● B
120°	12	● Y
		● R
		● G

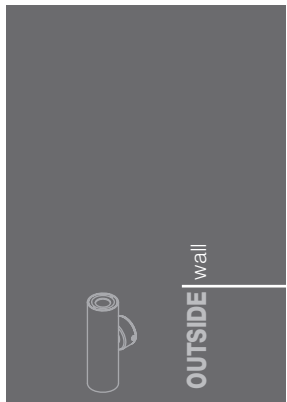

OUTSIDE wall

Aif

Aif

Corpo illuminante da parete a doppia emissione, interamente in alluminio.

Double-emission wall light. Aluminium case.

Applique à double émissions entièrement en Aluminium

Aplicque con doble emisión. Hecho enteramente en aluminio.

Wandleuchte mit Doppelemission, Ganz aus Aluminium.

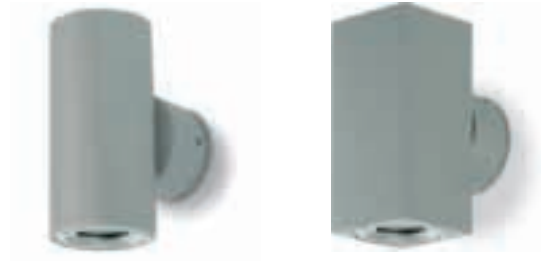

Driver compreso

Driver included
Driver compris
Driver incluido
inklusive Driver

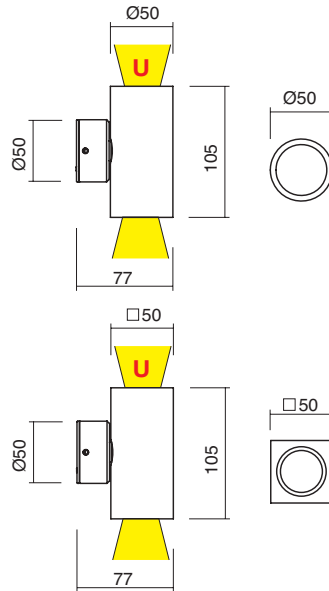

1 Watt

1+1 LED

85382	G
88049	CT

1 Watt

1+1 LED

85383	G
88050	CT

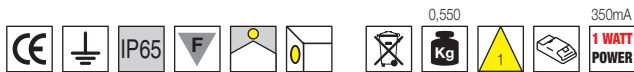

Esempio comp. codice
Example of code composition
Exemple comp. codes
Ejemplo de comp. del código
Beispiel Code-Zusammensetzung

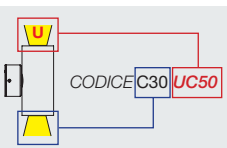

Colours	Opticals	code
C	10°	10
W	30°	30
N	50°	50
B	70°	70
Y	120°	12
R		
G		

- living outside



OUTSIDE wall



A1f



*Aplicae con doble emisión.
Hecho enteramente en aluminio.*

*Wandleuchte mit
Doppelemission, Ganz aus
Aluminium.*

A1f
Corpo illuminante
da parete a doppia
emissione, interamente
in alluminio.

*Double-emission wall light.
Aluminium case.*

*Applique à double
émissions entièrement en
Aluminium*

2 Watt

1+1 LED

G

85384

CT

88051

2 Watt

1+1 LED

G

85385

CT

88052

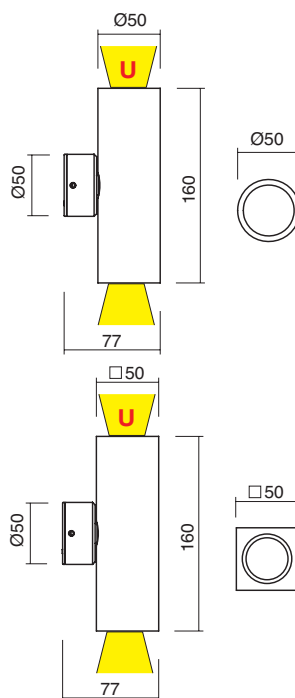

Driver compreso

*Driver included
Driver compris
Driver incluido
inklusive Driver*



Opticals	code	Colours
10°	10	● C
30°	30	● W
50°	50	○ N
70°	70	● B
120°	12	● Y
		● R
		● G

Esempio comp. codice

*Example of code composition
Ejemplo comp. codes
Ejemplo de comp. del código
Beispiel Code-Zusammensetzung*

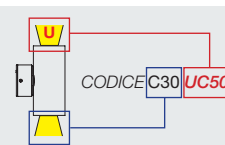



OUTSIDE wall

Flou

Flou

Corpo illuminante da parete a doppia emissione, interamente in alluminio.

Double-emission wall light. Aluminium case.

Applique à double émissions entièrement en Aluminium

Aplicque con doble emisión. Hecho enteramente en aluminio.

Wandleuchte mit Doppelemission, Ganz aus Aluminium.



Driver compreso

Driver included
Driver compris
Driver incluido
inklusive Driver

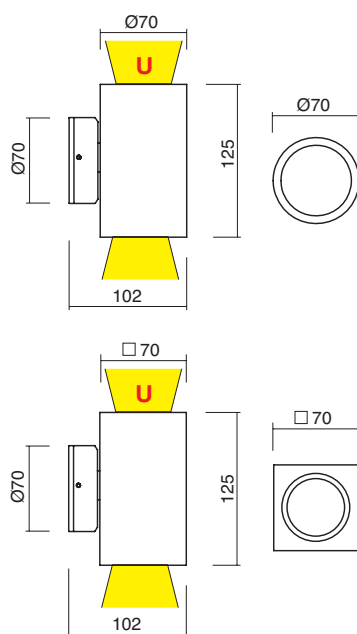

1 Watt

3+3 LED

85388

G

88053

CT

1 Watt

3+3 LED

85389

G

88054

CT



Esempio comp. codice

Example of code composition
Exemple comp. codes
Ejemplo de comp. del código
Beispiel Code-Zusammensetzung

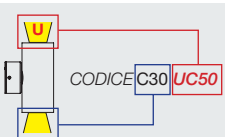

Colours	Opticals	code
● C	10°	10
● W	30°	30
● N	50°	50
● B	70°	70
● Y	120°	12
● R		
● G		

living outside



Cris



*Aplicque con doble emisión.
Hecho enteramente en aluminio.*

Wandleuchte mit Doppelermission, Ganz aus Aluminium.

Cris
Corpo illuminante da parete a doppia emissione, interamente in alluminio.

Double-emission wall light. Aluminium case.

Applique à double émissions entièrement en Aluminium

1 Watt

6+6 LED

G	85396
CT	88055

1 Watt

6+6 LED

G	85397
CT	88056

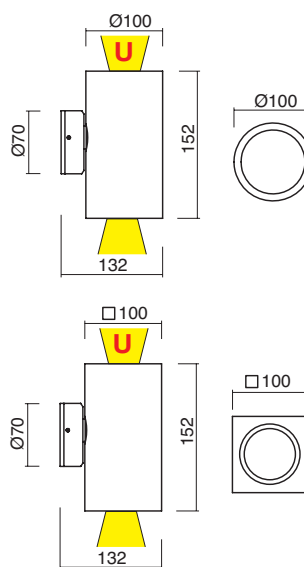

Driver compreso

*Driver included
Driver compris
Driver incluido
inklusive Driver*

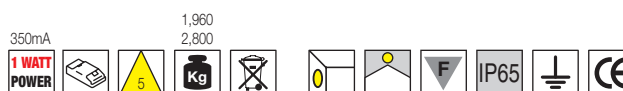

Opticals	code	Colours
10°	10	● C
30°	30	● W
50°	50	○ N
70°	70	● B
120°	12	● Y
		● R
		● G

Esempio comp. codice

*Example of code composition
Ejemplo comp. codes
Ejemplo de comp. del código
Beispiel Code-Zusammensetzung*

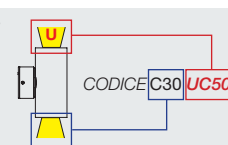

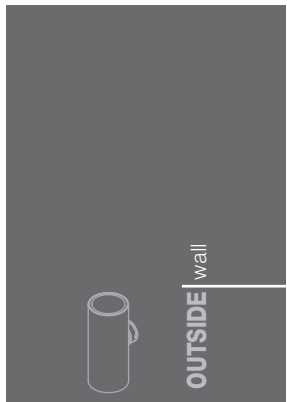

OUTSIDE wall

Cris

Cris

Corpo illuminante da parete a doppia emissione, interamente in alluminio.

Double-emission wall light. Aluminium case.

Applique à double émissions entièrement en Aluminium

Aplicque con doble emisión. Hecho enteramente en aluminio.

Wandleuchte mit Doppelemission, Ganz aus Aluminium.



Driver compreso

Driver included
Driver compris
Driver incluido
inklusive Driver

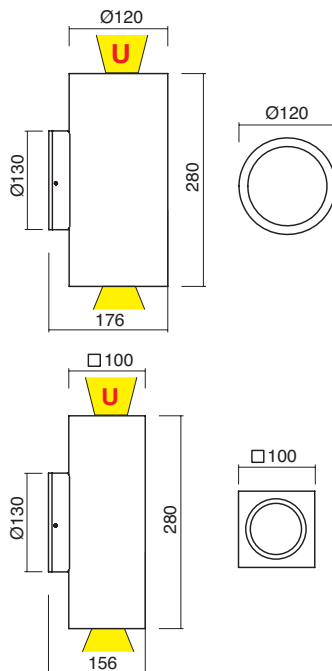

2 Watt

6+6 LED

85400

G

88057

CT

2 Watt

6+6 LED

85401

G

88058

CT

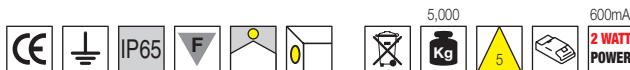

Esempio comp. codice

Example of code composition
Exemple comp. codes
Ejemplo de comp. del código
Beispiel Code-Zusammensetzung

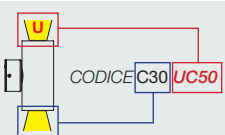

Colours	Opticals	code
● C	10°	10
● W	30°	30
● N	50°	50
● B	70°	70
● Y	120°	12
● R		
● G		

- living outside

OUTSIDE wall



Misal



Misal

Corpo illuminante da parete a doppia emissione, interamente in alluminio.

Double-emission wall light. Aluminium case.

Applique à double émissions entièrement en Aluminium

Aplicque con doble emisión. Hecho enteramente en aluminio.

Wandleuchte mit Doppelemission, Ganz aus Aluminium.

2 Watt

12+12 LED

G

85412

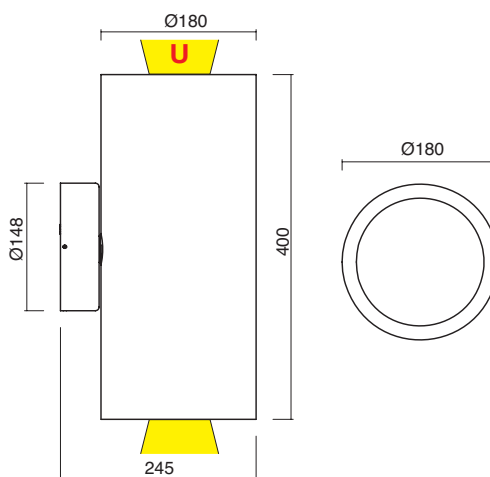

Driver compreso

Driver included
Driver compris
Driver incluido
inklusive Driver



Opticals	code	Colours
10°	10	● C
30°	30	● W
50°	50	○ N
70°	70	● B
120°	12	● Y
		● R
		● G

Esempio comp. codice

Example of code composition
Ejemplo comp. codes
Ejemplo de comp. del código
Beispiel Code-Zusammensetzung

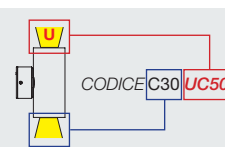



Profondi fasci di luce delinea-
no la struttura portante dell'edificio,
esaltandone le vecchie linee
architettoniche.

Progetto: Antica Trattoria - Modena - Italy
Lighting Design: LineaLight Group

Prodotti: Cris 6+6 led 2w

Deep beams of light outline the load-
bearing structure of the building and
set off its old architectural lines.

Project: Antica Trattoria - Modena - Italy
Lighting Design: LineaLight Group

Products used: Cris 6+6 leds 2w

De profonds faisceaux de lumière
tracent le contour de la structure
porteuse du bâtiment en mettant en
relief ses vieilles lignes architecturales.

Projet: Restaurant Antica Trattoria -
Modena - Italie
Design éclairage: LineaLight Group

Produits: Cris 6+6 leds 2ws

Los profundos haces de luz perfilan la
estructura del edificio, destacando sus
antiguas líneas arquitectónicas.

Proyecto: Antica Trattoria - Modena - Italia
Lighting Design: LineaLight Group

Productos: Cris 6+6 leds 2 w

Breite Lichtstrahlen umreißen die
tragende Struktur des Gebäudes und
stellen die alten architektonischen
Linien in den Vordergrund.

Projekt: Antica Trattoria - Modena - Italien
Lighting Design: LineaLight Group

Produkte: Cris 6+6 LED 2W

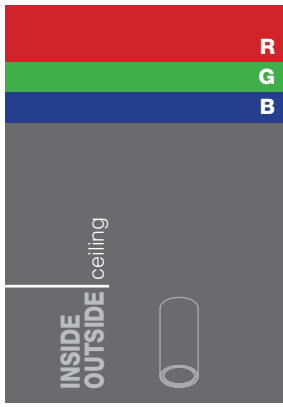

Ginny



Plafòn con òptica basculante para exterior (IP65) y hecho enteramente en aluminio.

Deckenleuchte mit schwenkbarem Lichtaustritt RGB, zur Anwendung im Außenbereich. Ganz aus Aluminium.

Ginny
Corpo illuminante da soffitto a ottica basculante per uso esterno (IP65). Interamente in alluminio.

Ceiling outdoor spotlight with adjustable optic, IP65 and aluminium case.

Spot pour plafond avec optique basculante pour utilisation en extérieur IP65 entièrement en Aluminium

	1 Watt RGB
	3 LED
G	85366
	1 Watt RGB
	3 LED
G	85367

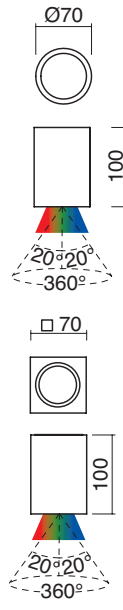

Driver NON compreso
Driver not included
Driver non compreso
Driver no incluido
exklusive Driver

vedi cap. Driver RGB
See RGB Driver section
Vori chapitre RGB Drivers
Ver capitolo Driver RGB
siehe Kap. "RGB Driver"

350mA 0,700 1,020

Opticals	code	Colours
10°	10	z
30°	30	
50°	50	
70°	70	
120°	12	

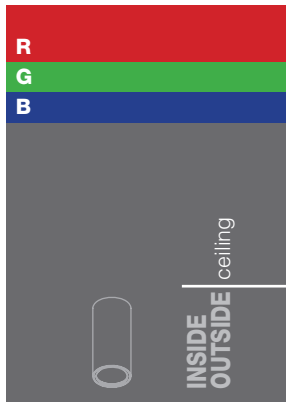

Ginny

Ginny

Corpo illuminante da soffitto a ottica basculante per uso esterno (IP65). Interamente in alluminio.

Ceiling outdoor spotlight with adjustable optic, IP65 and aluminium case.

Spot pour plafond avec optique basculante pour utilisation en extérieur IP65 entièrement en Aluminium

Plafòn con òptica basculante para exterior (IP65) y hecho enteramente en aluminio.

Deckenleuchte mit schwenkbarem Lichtaustritt RGB, zur Anwendung im Außenbereich. Ganz aus Aluminium.

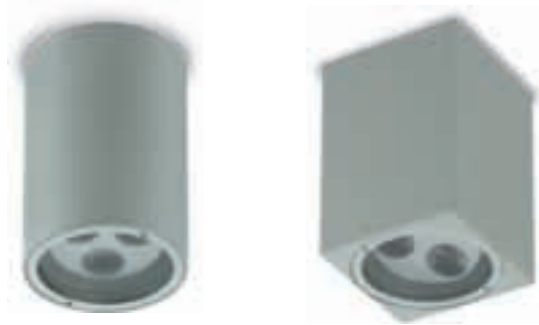

Driver NON compreso

Driver not included
Driver non compris
Driver no incluido
exklusive Driver

vedi cap. Driver RGB
See RGB Driver section
Vori chapitre RGB Drivers
Ver capitolo Driver RGB
siehe Kap. "RGB Driver"

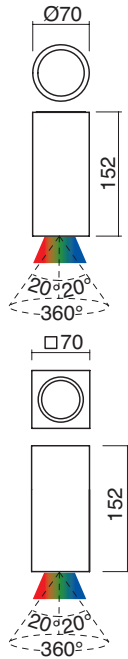

0,950
1,400
600mA



2 Watt RGB

3 LED

85368

G

2 Watt RGB

3 LED

85369

G

Colours Opticals code

 Z	10°	10
	30°	30
	50°	50
	70°	70
	120°	12

- living inside



- living outside



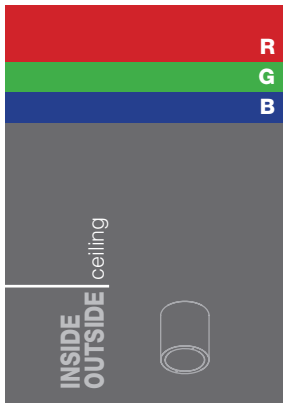

Ativ



Plafòn con òptica basculante para exterior (IP65) y hecho enteramente en aluminio.

Deckenleuchte mit schwenkbarem Lichtaustritt RGB, zur Anwendung im Außenbereich. Ganz aus Aluminium.

Ativ

Corpo illuminante da soffitto a ottica basculante per uso esterno (IP65). Interamente in alluminio.

Ceiling outdoor spotlight with adjustable optic, IP65 and aluminium case.

Spot pour plafond avec optique basculante pour utilisation en extérieur IP65 entièrement en Aluminium

	1 Watt RGB
	6 LED
G	85374

	1 Watt RGB
	6 LED
G	85375

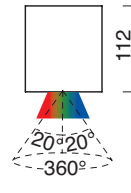
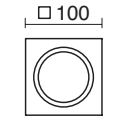
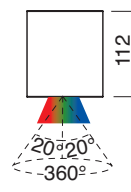
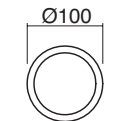

Driver NON compreso

Driver not included
Driver non compreso
Driver no incluido
exklusive Driver

vedi cap. Driver RGB
See RGB Driver section
Vori chapitre RGB Drivers
Ver capitulo Driver RGB
siehe Kap. "RGB Driver"



Opticals	code	Colours
10°	10	z
30°	30	
50°	50	
70°	70	
120°	12	

Ativ

Corpo illuminante da soffitto a ottica basculante per uso esterno (IP65). Interamente in alluminio.

Ceiling outdoor spotlight with adjustable optic, IP65 and aluminium case.

Spot pour plafond avec optique basculante pour utilisation en extérieur IP65 entièrement en Aluminium

Plafòn con òptica basculante para exterior (IP65) y hecho enteramente en aluminio.

Deckenleuchte mit schwenkbarem Lichtaustritt RGB, zur Anwendung im Außenbereich. Ganz aus Aluminium.



Driver NON compreso

Driver not included
Driver non compris
Driver no incluido
exklusive Driver

vedi cap. Driver RGB
See RGB Driver section
Vori chapitre RGB Drivers
Ver capitolo Driver RGB
siehe Kap. "RGB Driver"

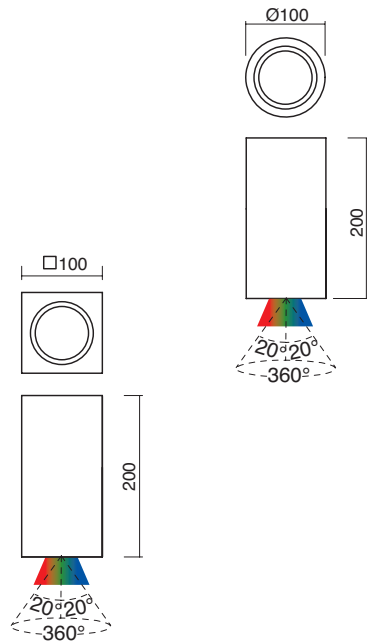

2 Watt RGB

6 LED

85376

G

2 Watt RGB

6 LED

85377

G



Colours	Opticals	code
RGB Z	10°	10
	30°	30
	50°	50
	70°	70
	120°	12

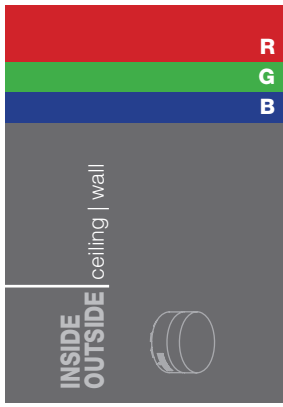

Algot



Aparato para aplicación a pared o a techo con difusor en polimetilmetacrilato, arenado internamente. Protección frontal en acero inox para recrear una emisión indirecta. Cuerpo en aluminio.

Wand- und Deckenleuchte mit Diffusor aus PMMA innen satiniert. Frontabdeckung aus Edelstahl, indirekter Lichtaustritt.

Algot

Corpo illuminante da parete o da soffitto con diffusore in polimetilmetacrilato con interno sabbiato. Protezione frontale in acciaio inox per ricreare un' emissione indiretta. Corpo in alluminio.

Wall and ceiling light with polymethyl methacrylate diffuser with sanded interior. Steel frontal protection for indirect emission. Aluminium case.

Spot à paroi ou plafond avec diffuseur en plexiglas dépoli de intérieur Protection frontal en Inox pour créer un émission direct. Corps en Aluminium.

Driver NON compreso

*Driver not included
Driver non compris
Driver no incluido
exklusive Driver*

*vedi cap. Driver RGB
See RGB Driver section
Vori chapitre RGB Drivers
Ver capitolo Driver RGB
siehe Kap. "RGB Driver"*

2 Watt RGB

6 LED

G

87446

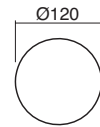
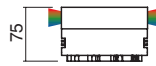

2 Watt RGB

6 LED

G

87449

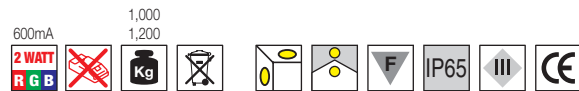
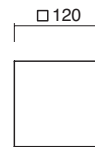

Opticals	code	Colours
Diffused	00	z

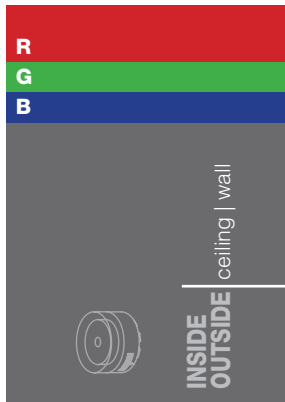

Algot

Algot

Corpo illuminante da parete o da soffitto con diffusore in polimetilmetacrilato con interno sabbciato ed esterno lucido. Corpo in alluminio.

Wall and ceiling light with polymethyl methacrylate diffuser with sanded interior and bright exterior. Aluminium case.

Spot à paroi ou plafond avec diffuseur en plexiglas dépoli de intérieur et translucide en extérieur. Corps en Aluminium.

Aparato para aplicación a pared o a techo con difusor polimetilmetacrilato, satinado y arenado internamente, lúcido externamente. Cuerpo hecho en aluminio.

Wand- oder Deckenleuchte mit Diffusor aus PMMA innen satiniert und hochglänzendem Gehäuse.



Driver NON compreso

Driver not included
Driver non compris
Driver no incluido
exklusive Driver

vedi cap. Driver RGB
See RGB Driver section
Vori chapitre RGB Drivers
Ver capitolo Driver RGB
siehe Kap. "RGB Driver"

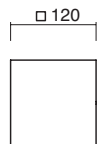
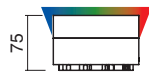
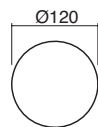
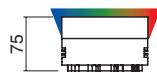

2 Watt RGB

6 LED

87859

G

2 Watt RGB

6 LED

87862

G

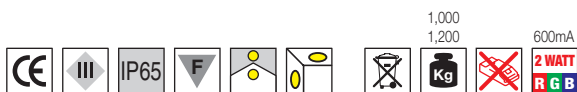

Colours

z

Opticals code

Diffused 00

- living inside

- living outside

e

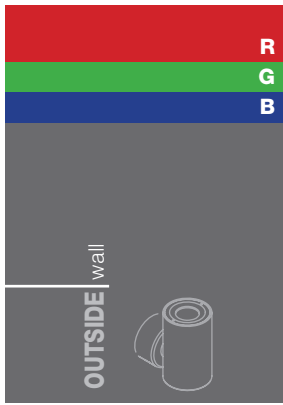

Ophil **MULTICHIP**
Technology



*Aplicque con única emisión.
Hecho enteramente en
aluminio.*

*Wandleuchte mit
einfachem Lichtaustritt,
Ganz
aus Aluminium.*

Ophil
Corpo illuminante da
parete ad emissione
singola interamente in
alluminio.

*Wall single emission
spotlight, full aluminium.*

*Applique à émission simple
entièrement en Aluminium*

1 Watt RGB

3 LED

G	86682
CT	88066

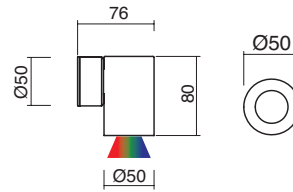

Driver NON compreso

*Driver not included
Driver non compris
Driver no incluido
exklusive Driver*

*vedi cap. Driver RGB
See RGB Driver section
Vori chapitre RGB Drivers
Ver capitulo Driver RGB
siehe Kap. "RGB Driver"*

1 Watt RGB

3 LED

G	86683
CT	88067

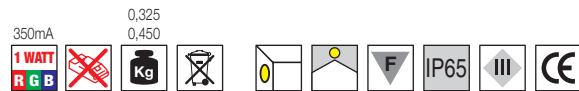
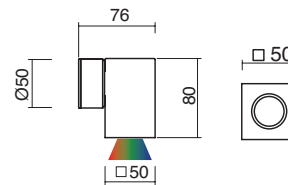

Opticals	code	Colours
50°	50	Z
70°	70	
120°	12	

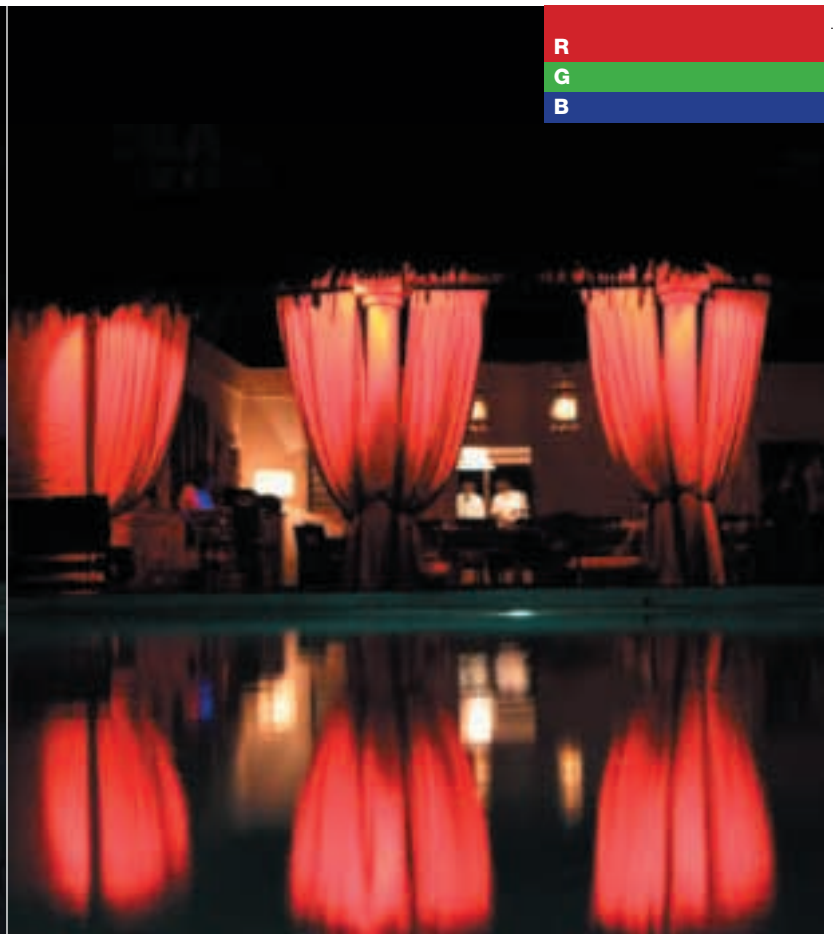

Effetti scenografici e dinamici ottenuti grazie alle piccole e non invasive plafoniere installate sul cornicione della struttura in legno.

This courtyard is well-lit by means of a diffused light that makes it possible to use this outdoor space in complete freedom and comfort.

Des effets dynamiques et décoratifs obtenus grâce aux petits plafonniers à la lumière non agressive installés sur la cornise de la structure en bois.

Efectos escenográficos y dinámicos obtenidos gracias a los pequeños y nunca molestos plafones de techo instalados en la cornisa de la estructura de madera.

Durch die kleinen und unauffälligen Deckenleuchten, die auf dem Rahmen der Holzstruktur montiert sind entstehen bühnenreife und stimmungsvolle Lichteffekte.

Progetto: Resort, Malindi KENIA
Lighting Design: Teleimpianti - Mario Monaco

*Project: Private home -Treviso - Italy
Lighting Design: Teleimpianti - Mario Monaco*

*Projet: Resort, Malindi KENYA
Design éclairage: Teleimpianti - Mario Monaco*

*Proyecto: Resort, Malindi KENIA
Lighting Design: Teleimpianti - Mario Monaco*

*Projekt: Urlaubsresort, Malindi KENIA
Lighting Design: Teleimpianti - Mario Monaco*

Prodotti: Ativ 6 Led 2 watt RGB

Produits: Ativ 6 Leds 2 watts RGB

Products used: Ativ 6 Leds 2 watts RGB

Productos: Ativ 6 leds 2 watt RGB

Produkte: Ativ 6 LED 2 Watt RGB

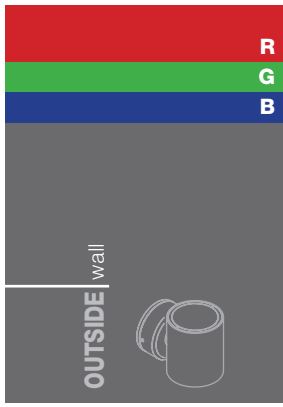

Atsia



*Aplicue con única emisión.
Hecho enteramente en aluminio.*

*Wandleuchte mit
Einzelemission, Ganz
aus Aluminium.*

Atsia

Corpo illuminante da parete ad emissione singola interamente in alluminio.

Wall single emission spotlight, full aluminium.

Applique à émission simple entièrement en Aluminium

1 Watt RGB

3 LED

G	85390
CT	88068

1 Watt RGB

3 LED

G	85391
CT	88069

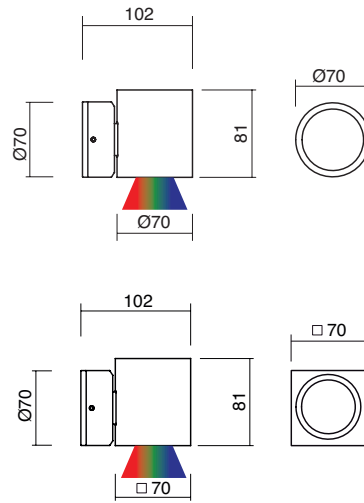

Driver NON compreso

*Driver not included
Driver non compris
Driver no incluido
exklusive Driver*

*vedi cap. Driver RGB
See RGB Driver section
Vori chapitre RGB Drivers
Ver capitulo Driver RGB
siehe Kap. "RGB Driver"*

350mA 0.565 0.800

Opticals	code	Colours
10°	10	z
30°	30	
50°	50	
70°	70	
120°	12	

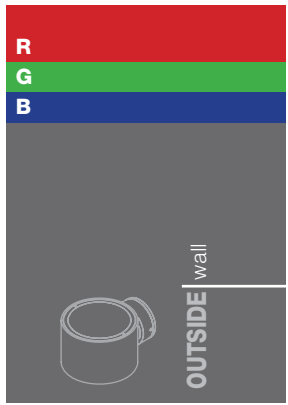

Elix

Elix

Corpo illuminante da parete ad emissione singola interamente in alluminio.

Wall single emission spotlight, full aluminium.

Applique à émission simple entièrement en Aluminium

Aplicque con única emisión. Hecho enteramente en aluminio.

Wandleuchte mit Einzelemission, Ganz aus Aluminium.



Driver NON compreso

Driver not included
Driver non compris
Driver no incluido
exklusive Driver

vedi cap. Driver RGB
See RGB Driver section
Vori chapitre RGB Drivers
Ver capitulo Driver RGB
siehe Kap. "RGB Driver"

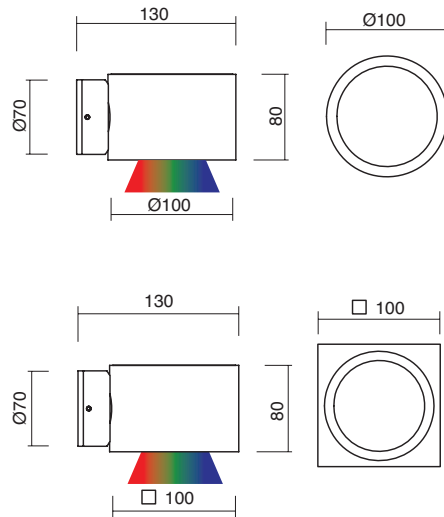

1 Watt RGB

6 LED

85532	G
88070	CT

1 Watt RGB

6 LED

85533	G
88071	CT

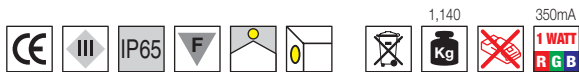

Colours	Opticals	code
Z	10°	10
	30°	30
	50°	50
	70°	70
	120°	12

- living outside



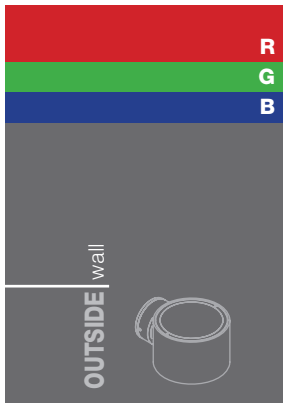

Elix



Elix

*Aplicue con única emisión.
Hecho enteramente en aluminio.*

Wandleuchte mit Einzelemission, Ganz aus Aluminium.

Corpo illuminante da parete ad emissione singola interamente in alluminio.

Wall single emission spotlight, full aluminium.

Applique à émission simple entièrement en Aluminium

2 Watt RGB

6 LED

G	85402
CT	88072

2 Watt RGB

6 LED

G	85403
CT	88073

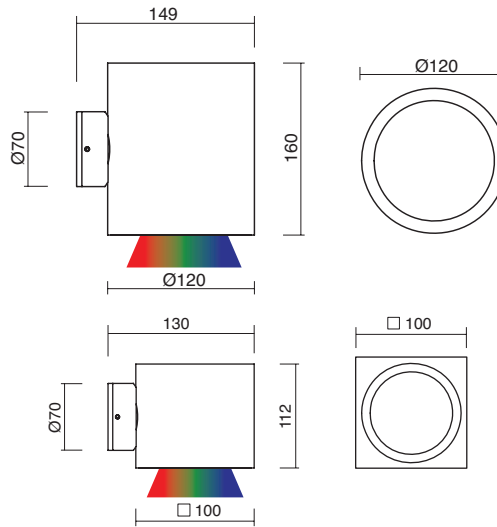

Driver NON compreso

*Driver not included
Driver non compris
Driver no incluido
exklusive Driver*

*vedi cap. Driver RGB
See RGB Driver section
Vori chapitre RGB Drivers
Ver capitulo Driver RGB
siehe Kap. "RGB Driver"*

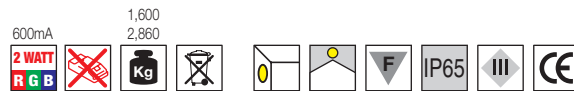

Opticals	code	Colours
10°	10	z
30°	30	
50°	50	
70°	70	
120°	12	

Decos

Corpo illuminante da parete ad emissione singola interamente in alluminio.

Wall single emission spotlight, full aluminium.

Applique à émission simple entièrement en Aluminium

Aplicque con única emisión. Hecho enteramente en aluminio.

Wandleuchte mit Einzelemission, Ganz aus Aluminium.



Driver NON compreso

Driver not included
Driver non compris
Driver no incluido
exklusive Driver

vedi cap. Driver RGB
See RGB Driver section
Vori chapitre RGB Drivers
Ver capitulo Driver RGB
siehe Kap. "RGB Driver"

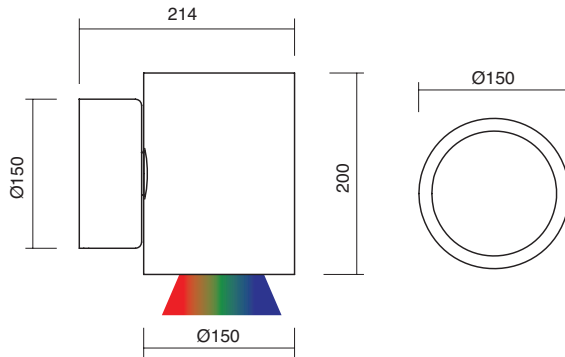

1 Watt RGB 2 Watt RGB

12 LED 12 LED

85414 85418

G

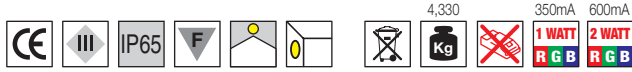

Colours	Opticals	code
Z	10°	10
	30°	30
	50°	50
	70°	70
	120°	12



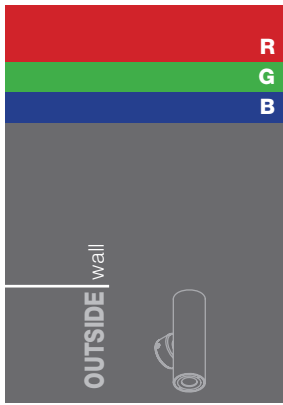

Aif MULTICHIP Technology



Aif

Corpo illuminante da parete a doppia emissione, interamente in alluminio.

Double-emission wall light. Aluminium case.

Applique à double émissions entièrement en Aluminium

Applique con doble emisión. Hecho enteramente en aluminio.

Wandleuchte mit Doppelsonnenstrahlung, Ganz aus Aluminium.

1 Watt RGB

3+3 LED

G	86684
CT	88074

1 Watt RGB

3+3 LED

G	86685
CT	88075

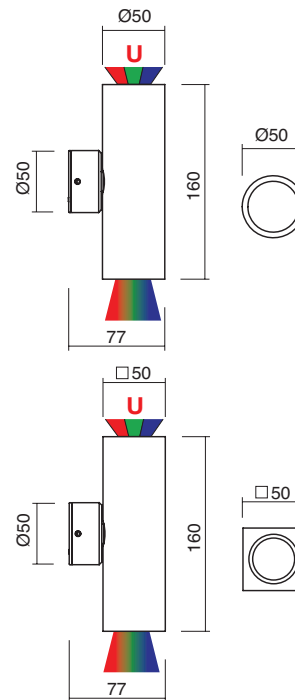

Driver NON compreso

*Driver not included
Driver non compris
Driver no incluido
exklusive Driver*

*vedi cap. Driver RGB
See RGB Driver section
Vori chapitre RGB Drivers
Ver capitulo Driver RGB
siehe Kap. "RGB Driver"*

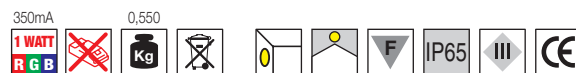

Opticals	code	Colours
50°	50	Z
70°	70	
120°	12	

Esempio comp. codice

*Example of code composition
Exemple comp. codes
Ejemplo de comp. del código
Beispiel Code-Zusammensetzung*

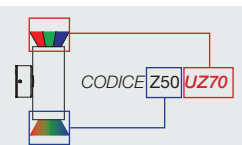

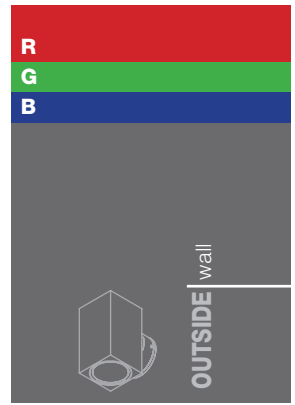

Flou

Flou

Corpo illuminante da parete a doppia emissione, interamente in alluminio.

Double-emission wall light. Aluminium case.

Applique à double émissions entièrement en Aluminium

Aplicque con doble emisión. Hecho enteramente en aluminio.

Wandleuchte mit Doppelemission, Ganz aus Aluminium.



Driver NON compreso

Driver not included
Driver non compris
Driver no incluido
exklusive Driver

vedi cap. Driver RGB
See RGB Driver section
Vori chapitre RGB Drivers
Ver capitulo Driver RGB
siehe Kap. "RGB Driver"

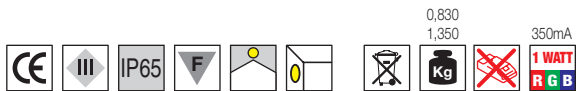
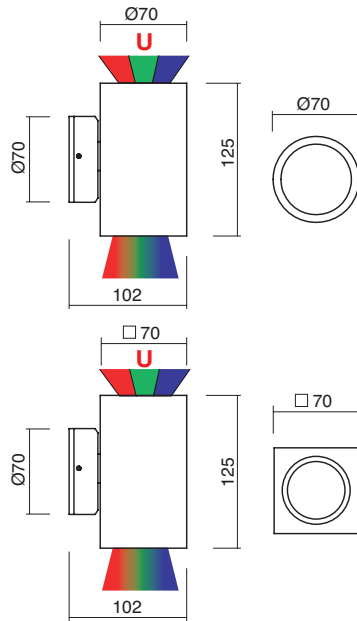

1 Watt RGB

3+3 LED

85392	G
88076	CT

1 Watt RGB

3+3 LED

85393	G
88077	CT

Esempio comp. codice

Example of code composition
Exemple comp. codes
Ejemplo de comp. del código
Beispiel Code-Zusammensetzung

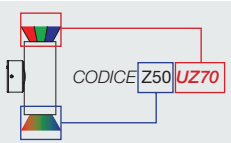

Colours	Opticals	code
Z	10°	10
	30°	30
	50°	50
	70°	70
	120°	12

- living outside



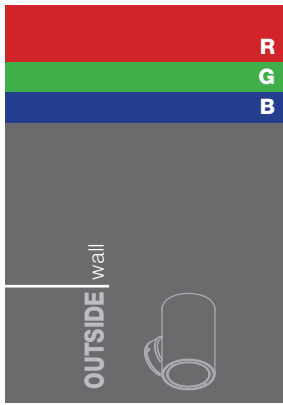

Cris



*Aplicue con doble emisión.
Hecho enteramente en aluminio.*

Wandleuchte mit Doppelermission, Ganz aus Aluminium.

Cris

Corpo illuminante da parete a doppia emissione, interamente in alluminio.

Double-emission wall light. Aluminium case.

Applique à double émissions entièrement en Aluminium

1 Watt RGB

6+6 LED

G	85534
CT	88078

1 Watt RGB

6+6 LED

G	85535
CT	88079

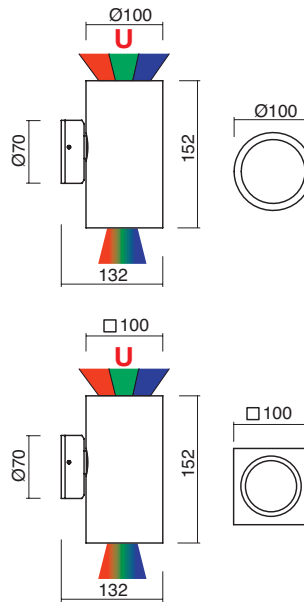

Driver NON compreso

*Driver not included
Driver non compris
Driver no incluido
exklusive Driver*

*vedi cap. Driver RGB
See RGB Driver section
Vori chapitre RGB Drivers
Ver capitulo Driver RGB
siehe Kap. "RGB Driver"*

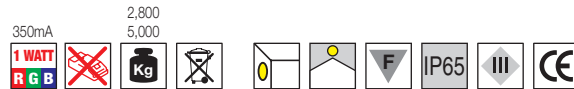

Opticals	code	Colours
10°	10	z
30°	30	
50°	50	
70°	70	
120°	12	

Esempio comp. codice

*Example of code composition
Exemple comp. codes
Ejemplo de comp. del código
Beispiel Code-Zusammensetzung*

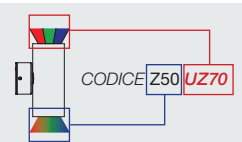

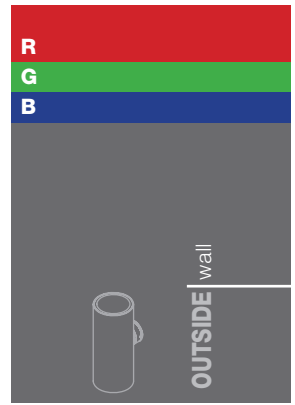

Cris

Cris

Corpo illuminante da parete a doppia emissione, interamente in alluminio.

Double-emission wall light. Aluminium case.

Applique à double émissions entièrement en Aluminium

Aplicque con doble emisión. Hecho enteramente en aluminio.

Wandleuchte mit Doppelemission, Ganz aus Aluminium.



Driver NON compreso

Driver not included
Driver non compris
Driver no incluido
exklusive Driver

vedi cap. Driver RGB
See RGB Driver section
Vori chapitre RGB Drivers
Ver capitulo Driver RGB
siehe Kap. "RGB Driver"

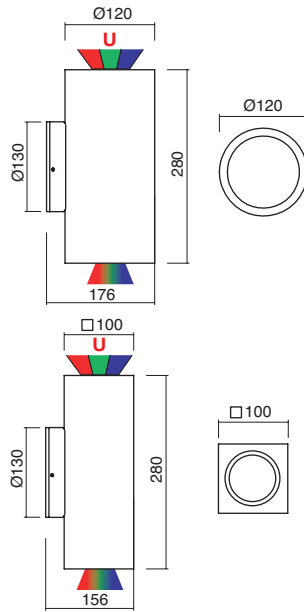

2 Watt RGB

6+6 LED

85404	G
88080	CT

2 Watt RGB

6+6 LED

85405	G
88081	CT

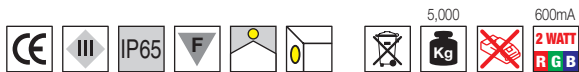

Colours	Opticals	code
---------	----------	------

Z	10°	10
	30°	30
	50°	50
	70°	70
	120°	12

Esempio comp. codice

Example of code composition
Exemple comp. codes
Ejemplo de comp. del código
Beispiel Code-Zusammensetzung

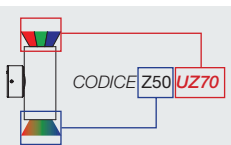

- living outside

